

inny wariant układu rzutów

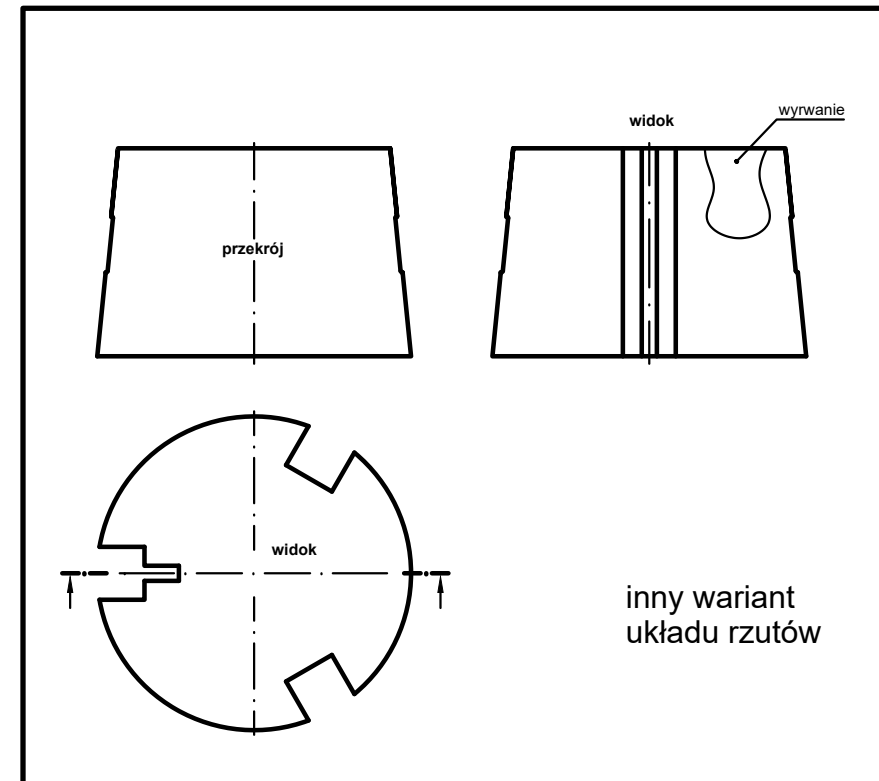

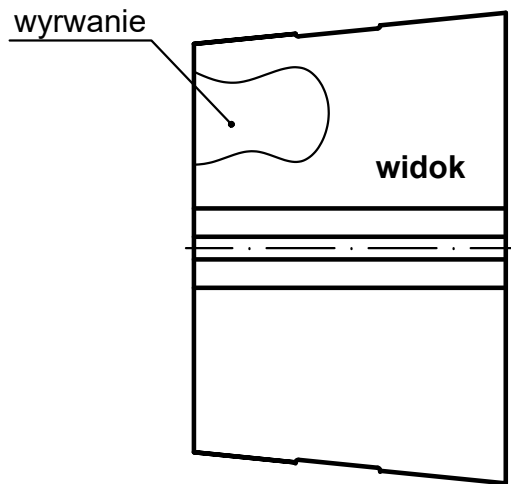

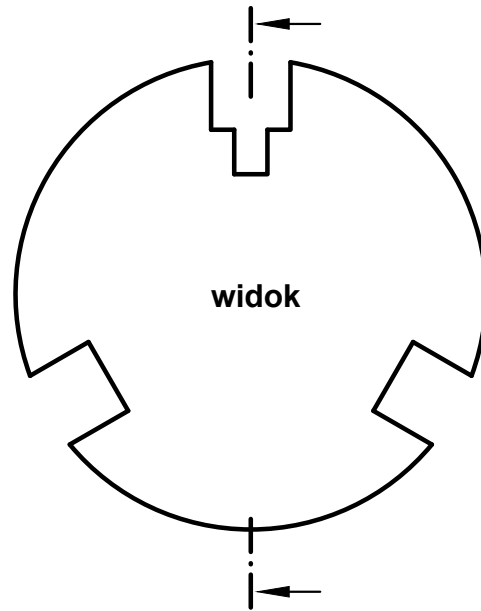

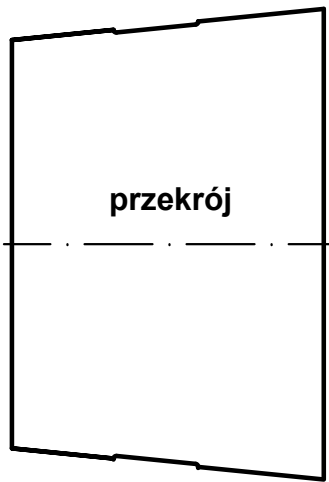
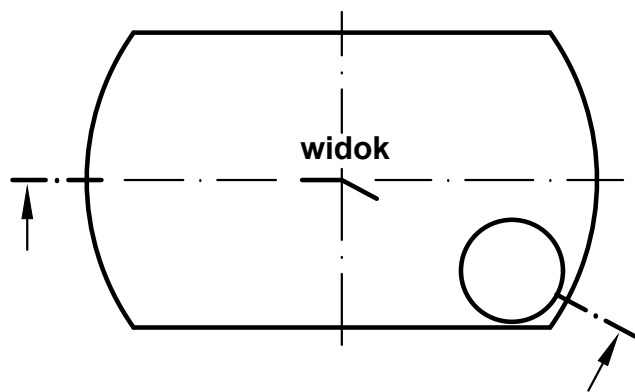
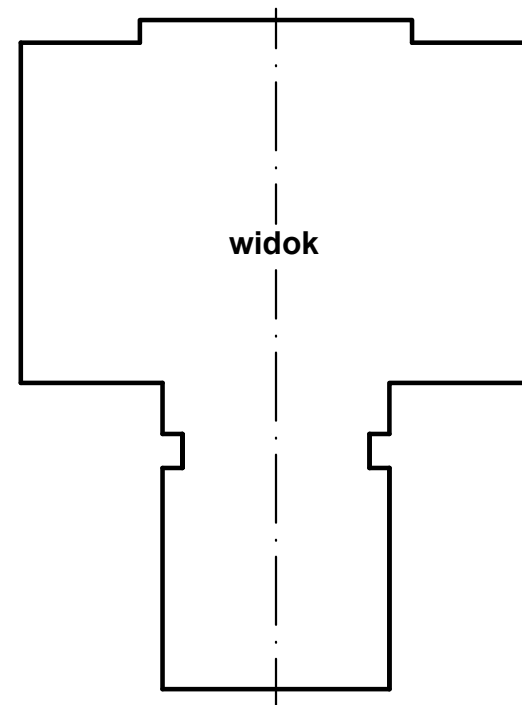
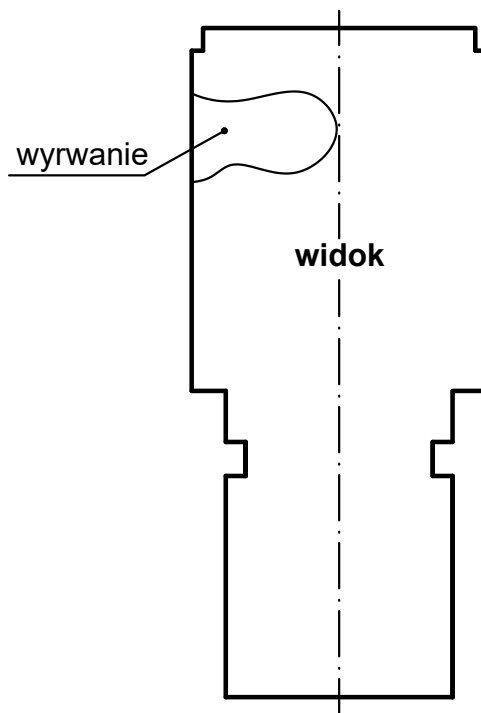
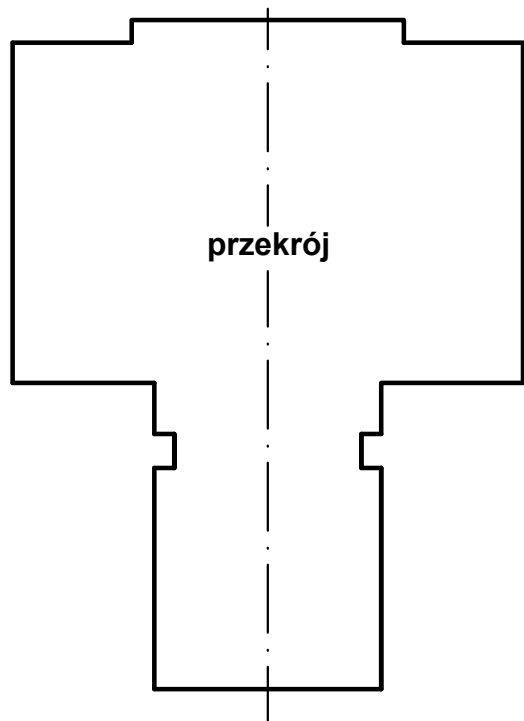
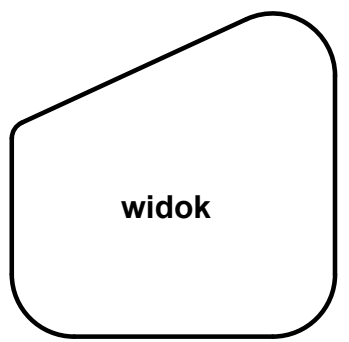
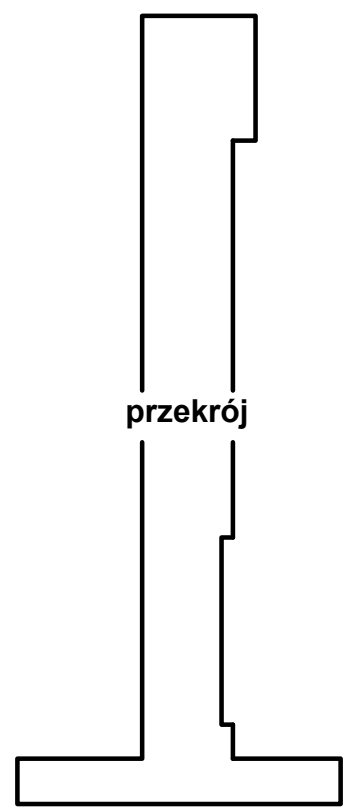
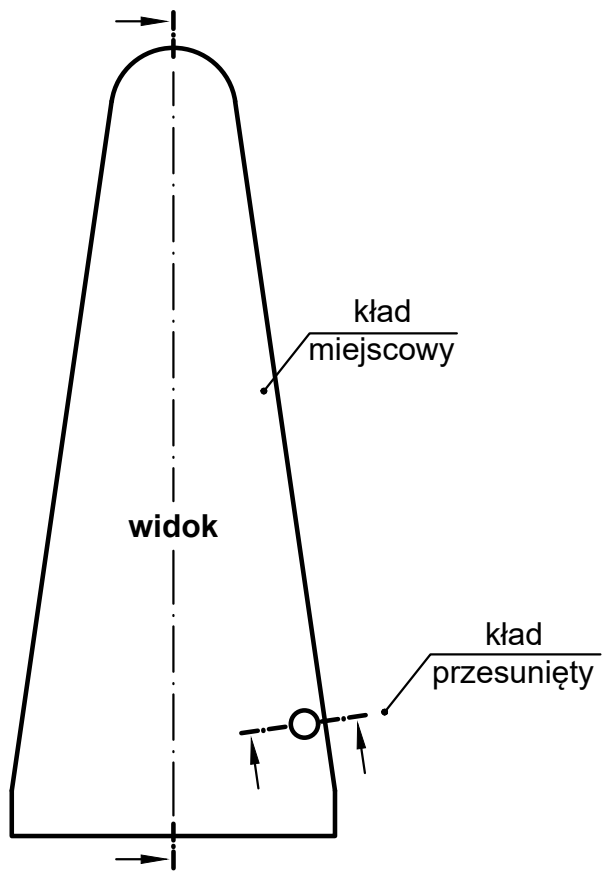
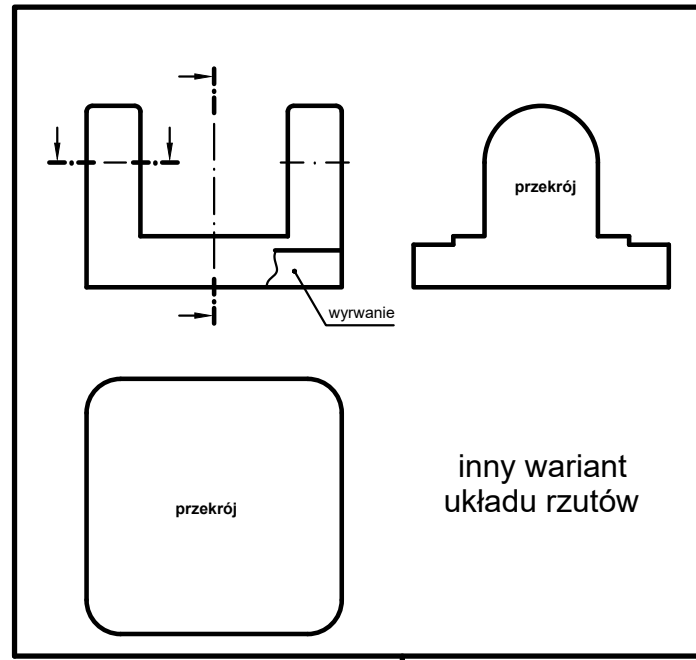
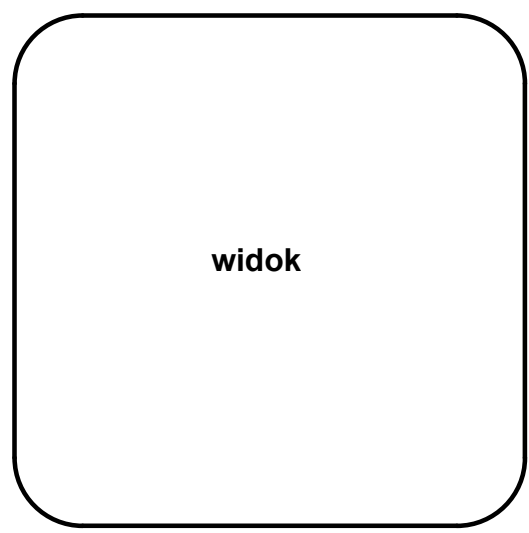
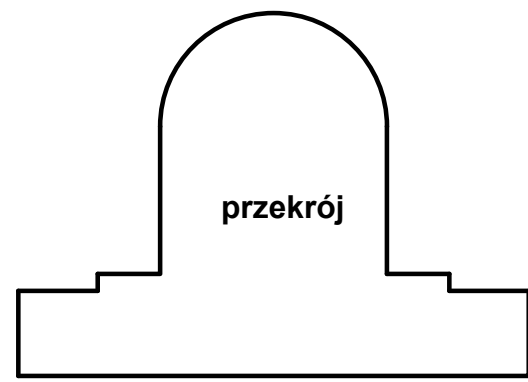
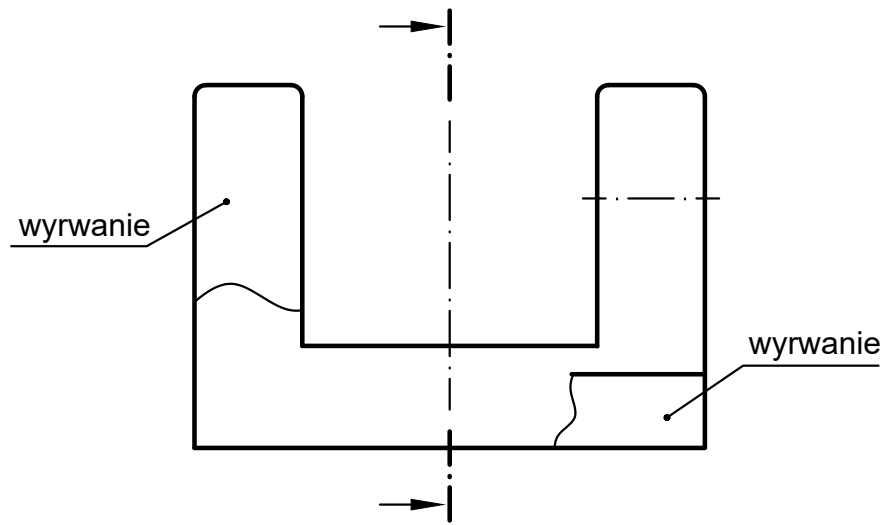

urwany kład  
przesunięty

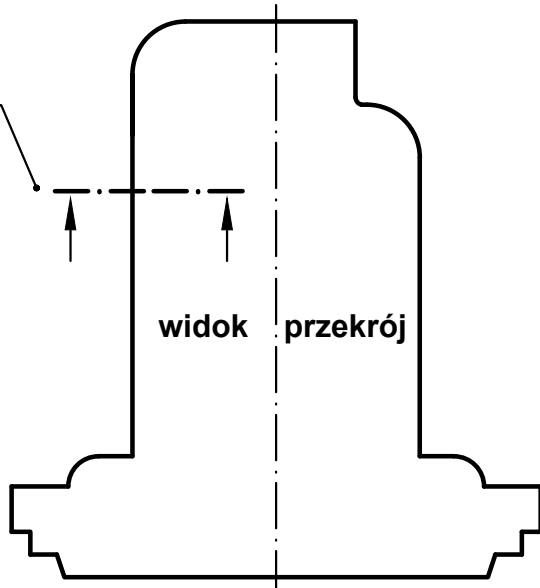

wyrwanie

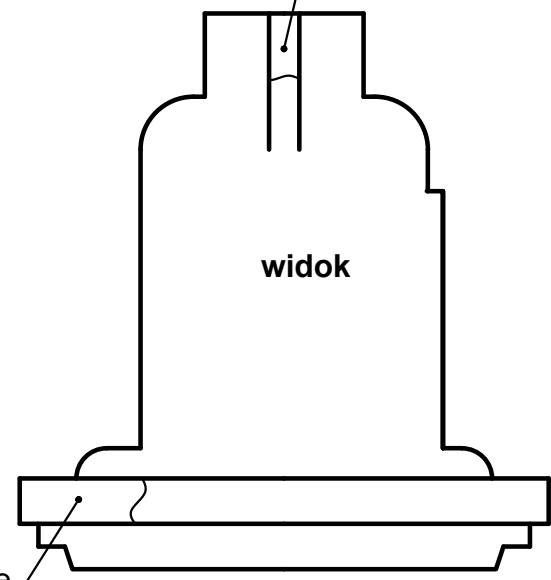

widok

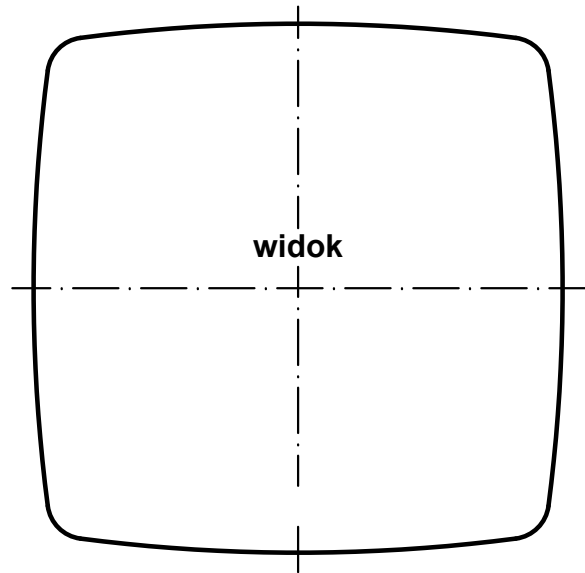



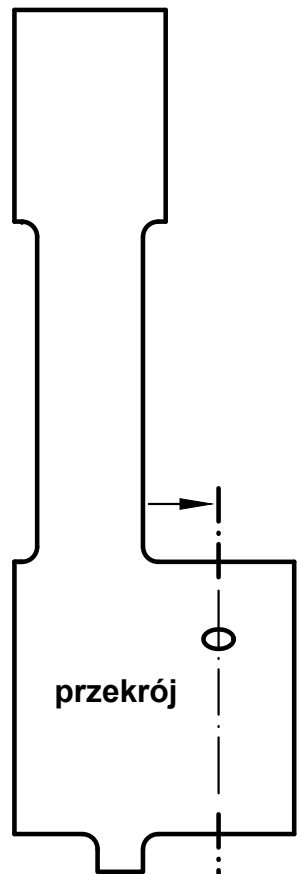

przekrój



kład przesunięty

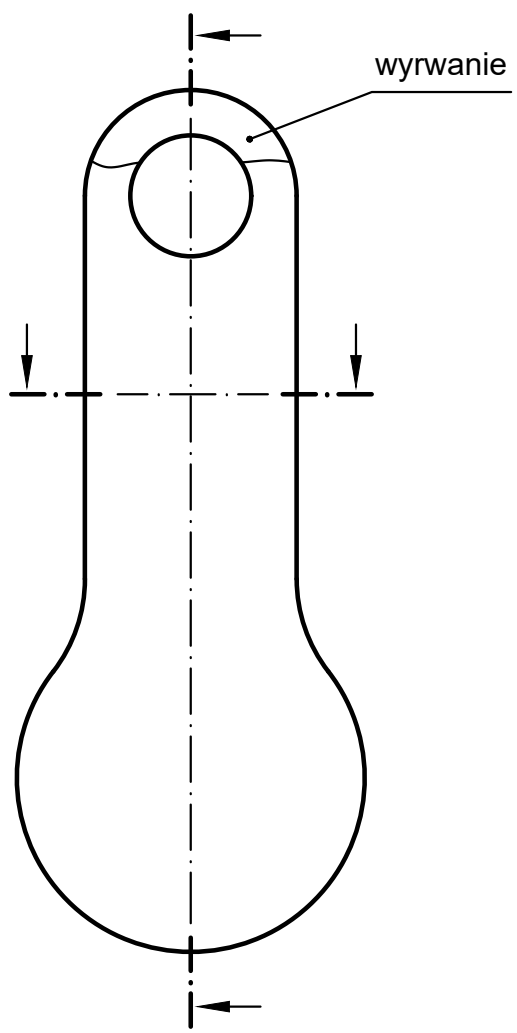

wyrwanie

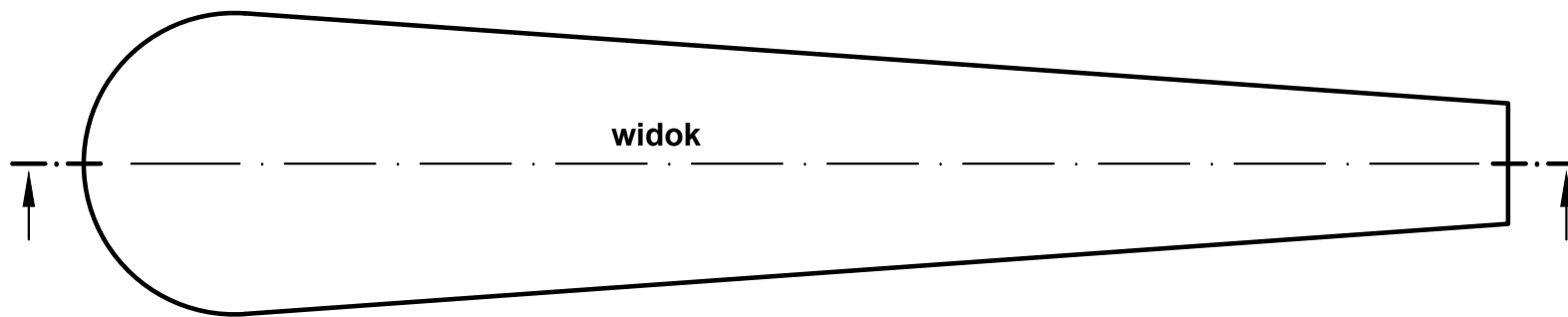
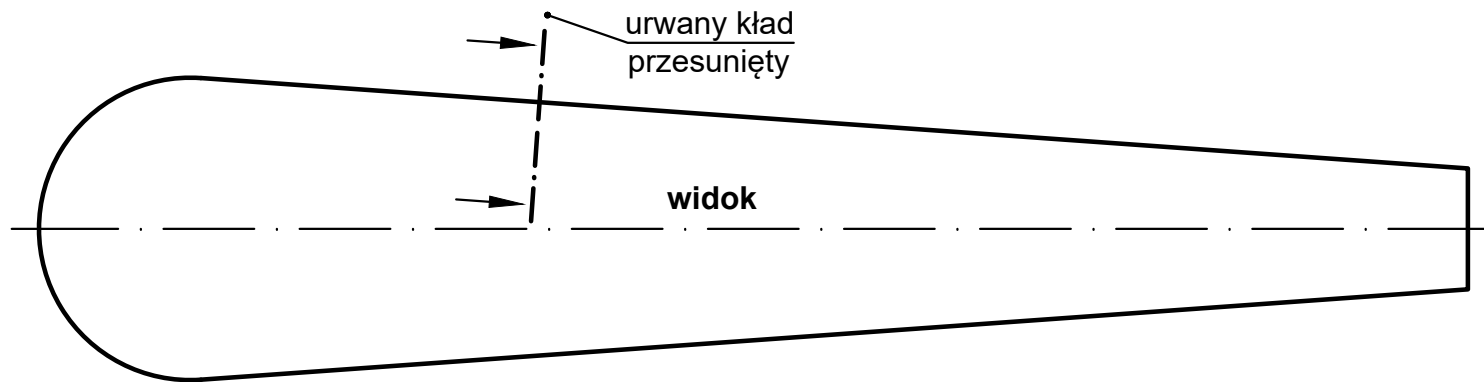

**B (2:1)**

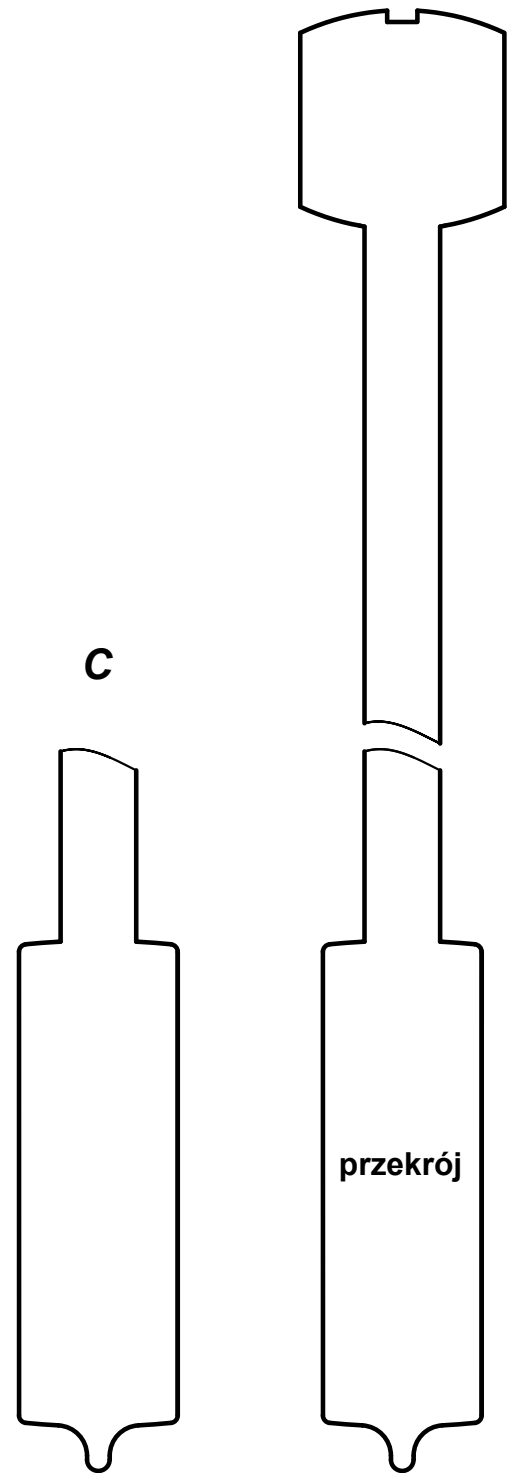
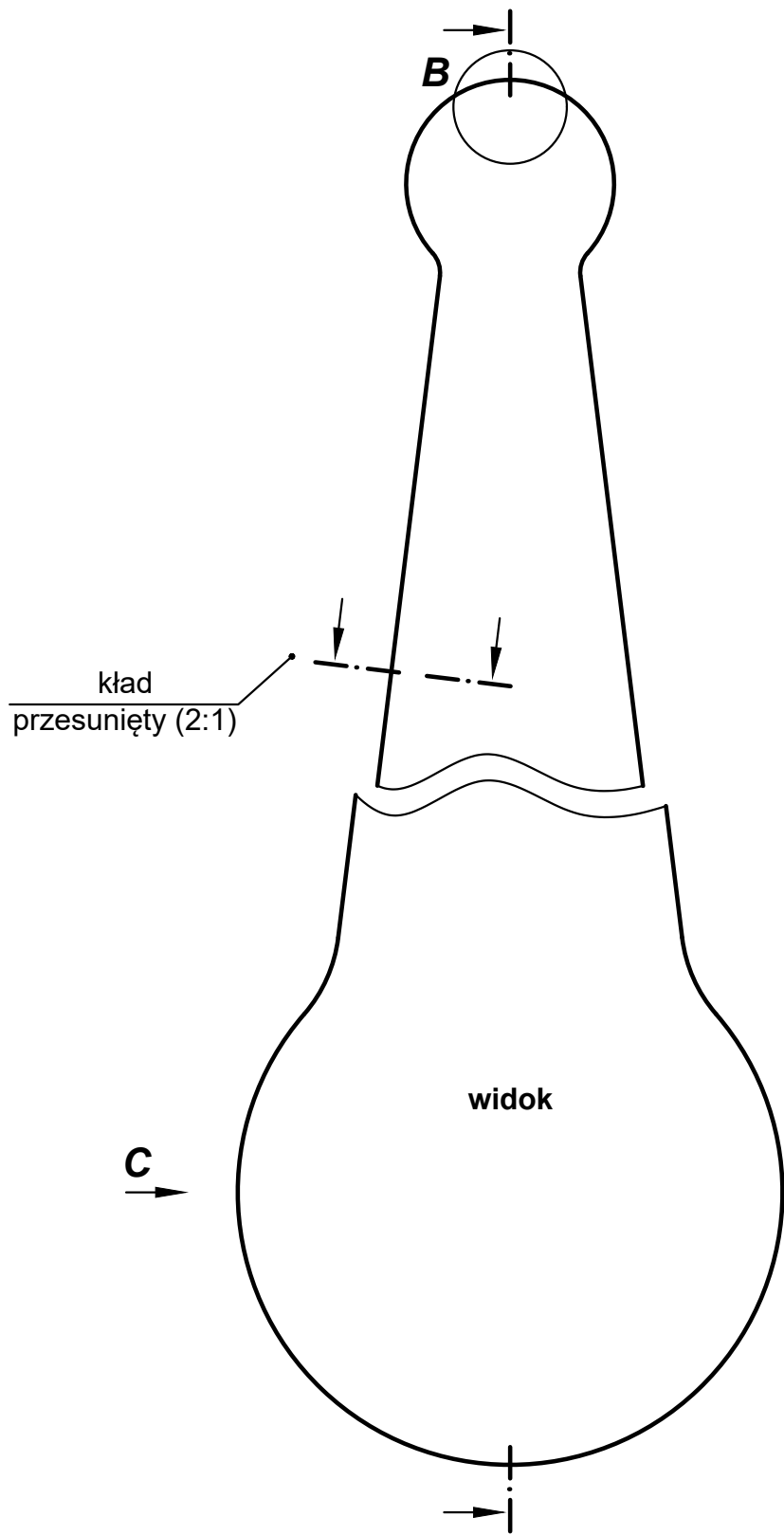

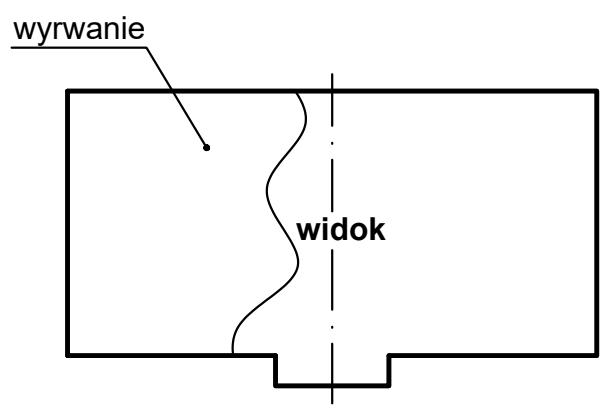
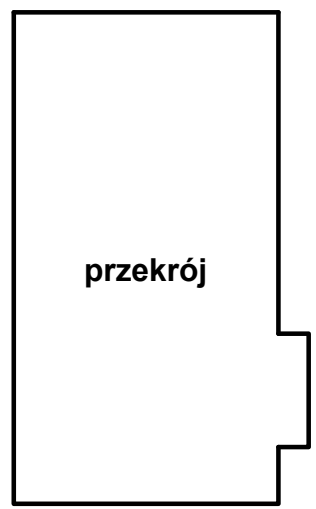
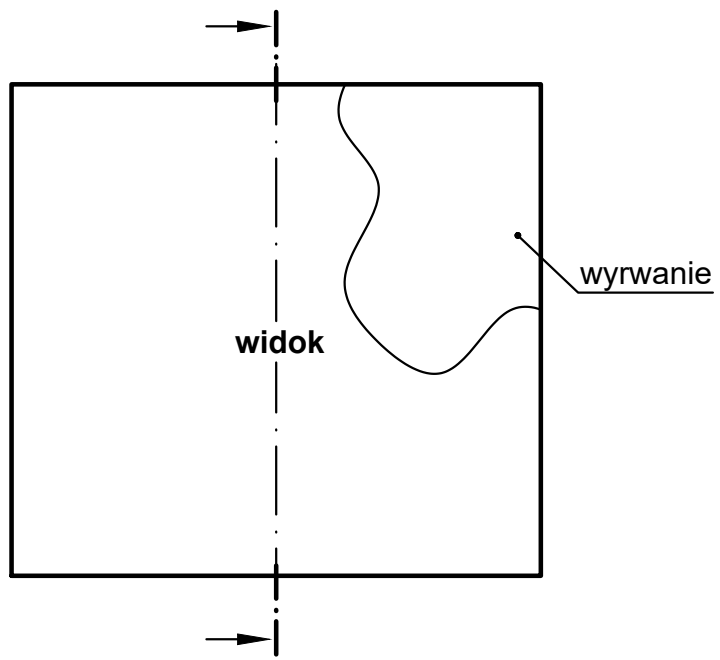

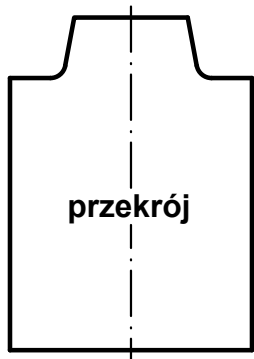

przekrój

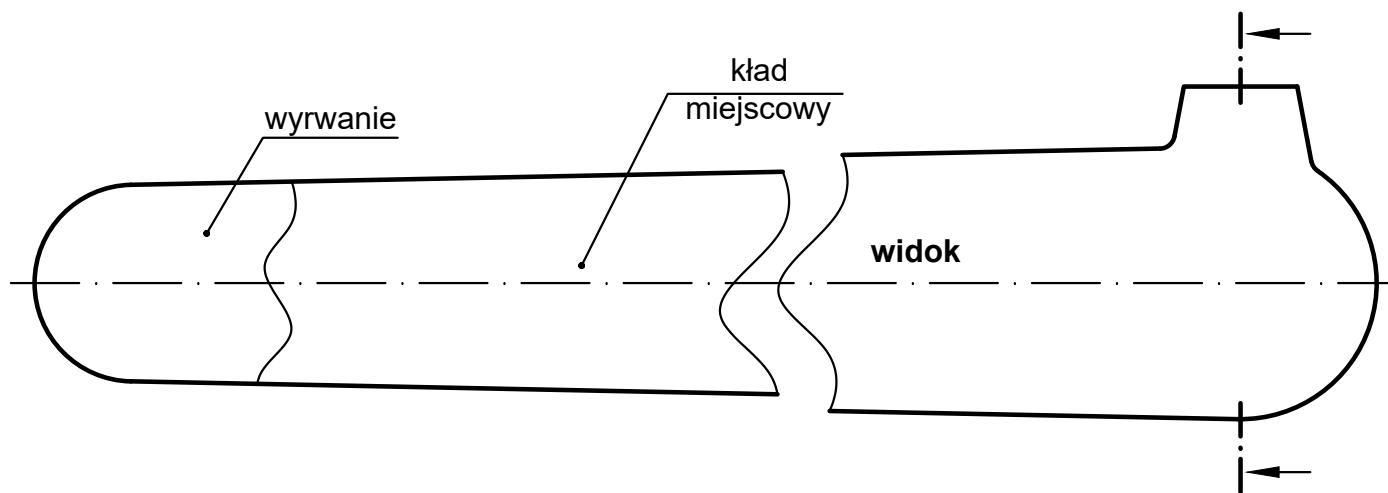

wyrwanie

kład  
miejscowy

widok

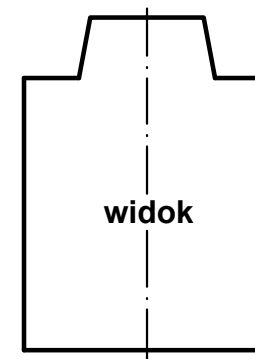

widok

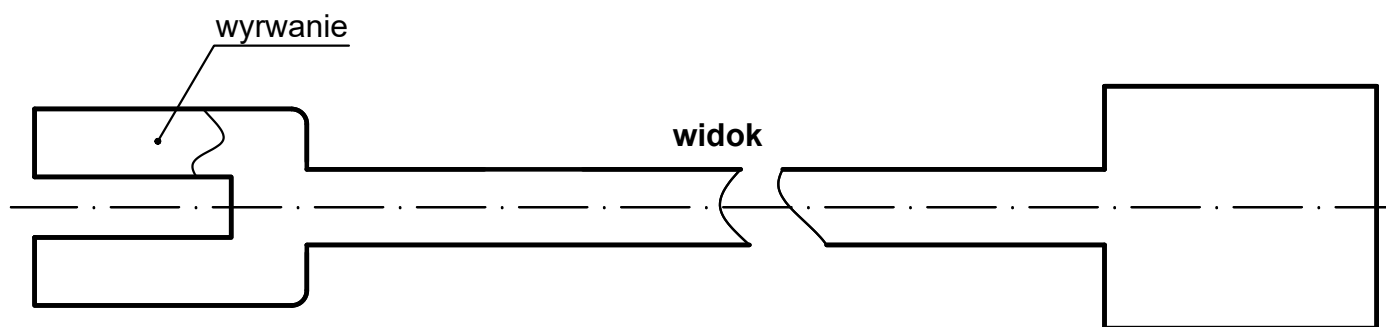

wyrwanie

widok

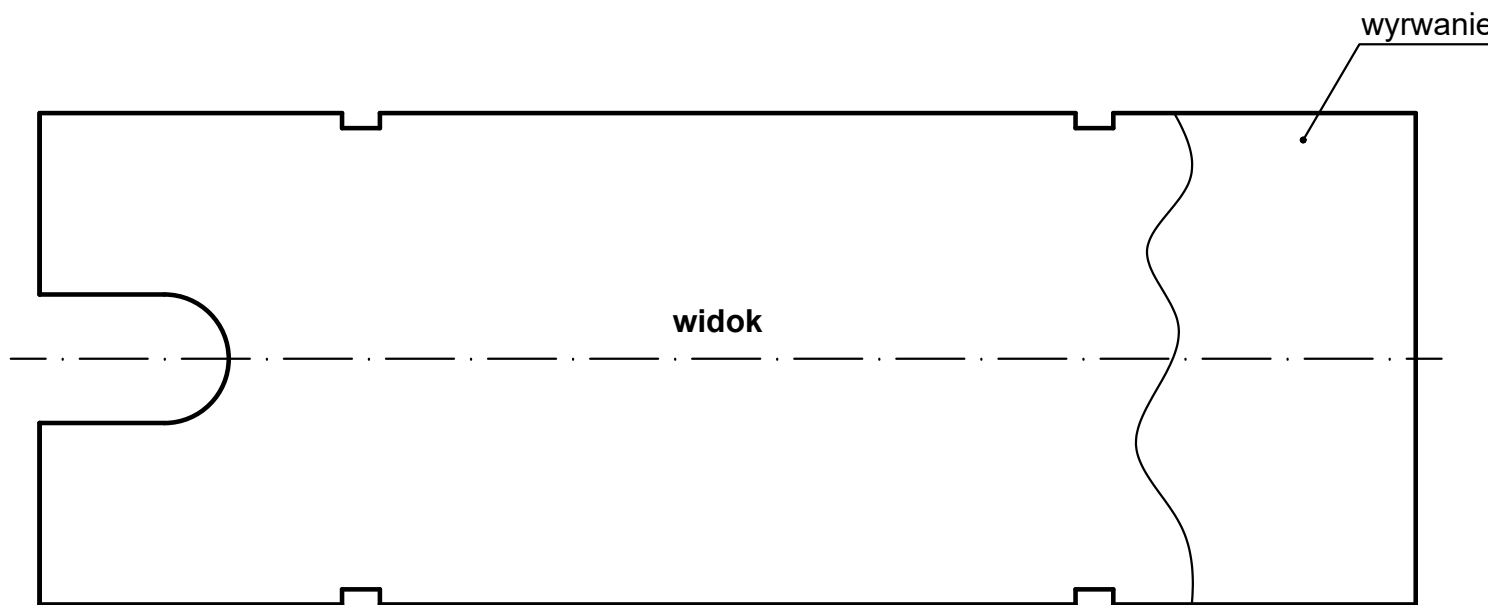
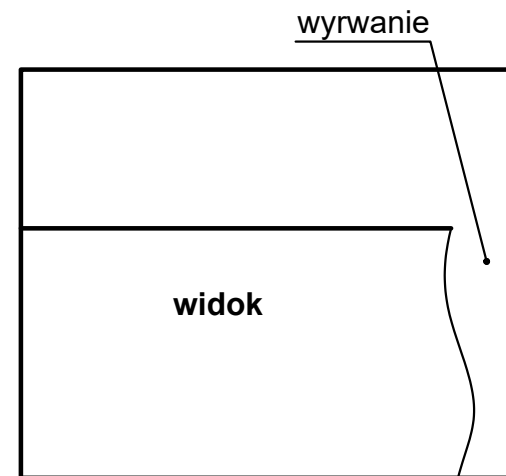
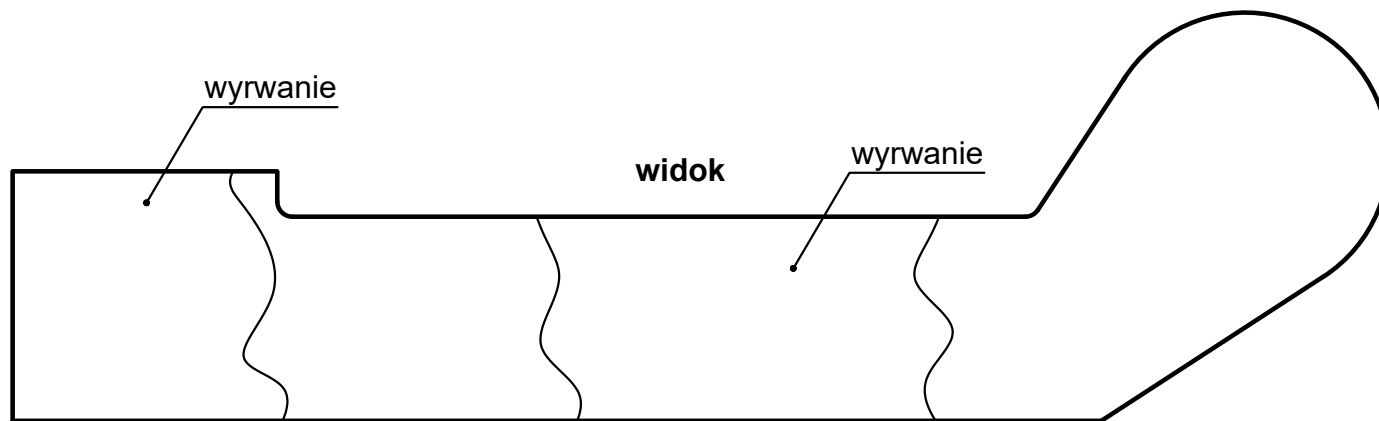

**A**

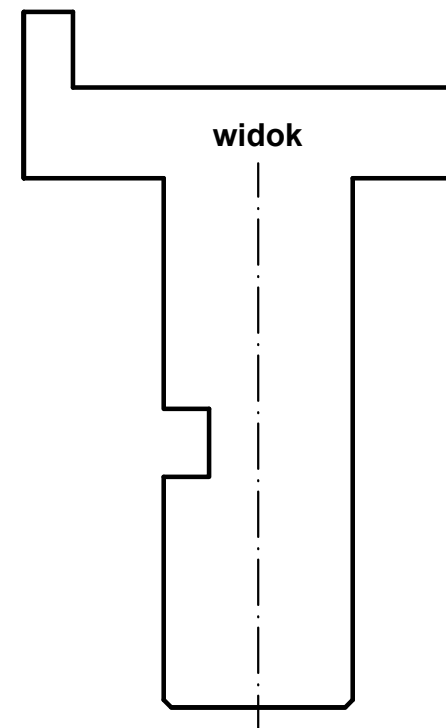
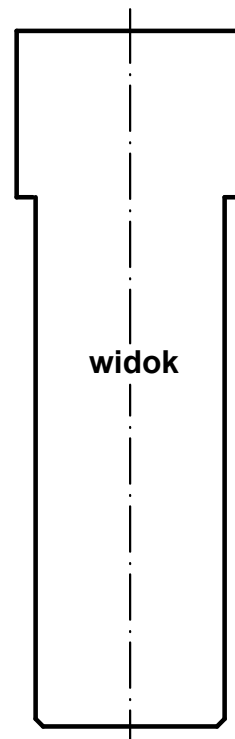
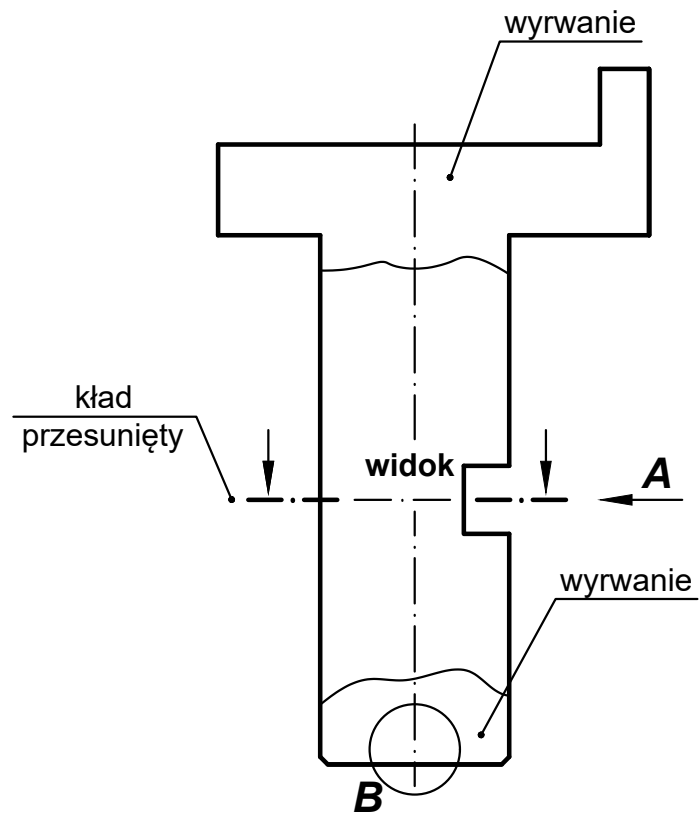

**B (2:1)**

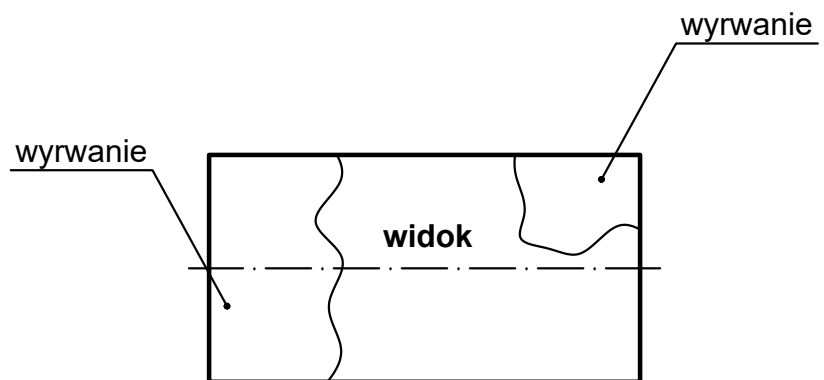

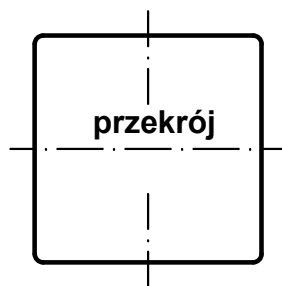
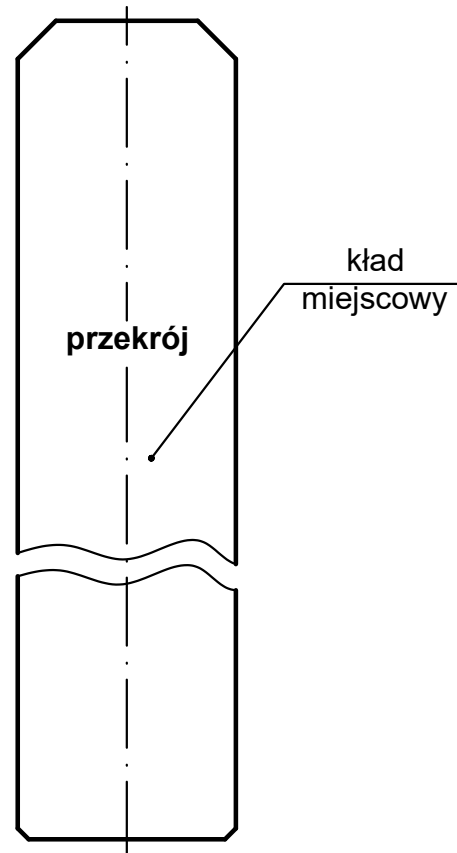
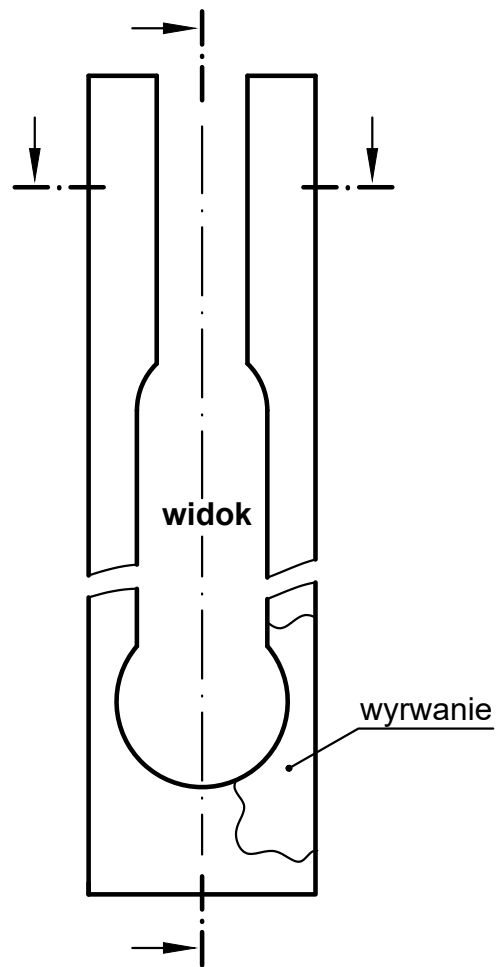



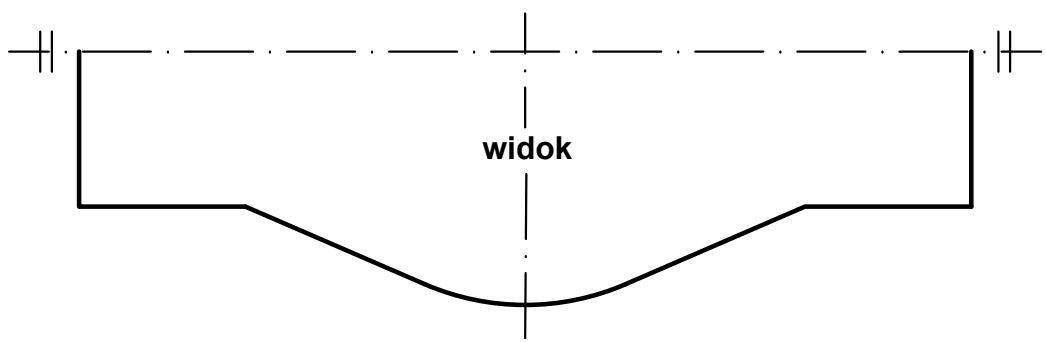
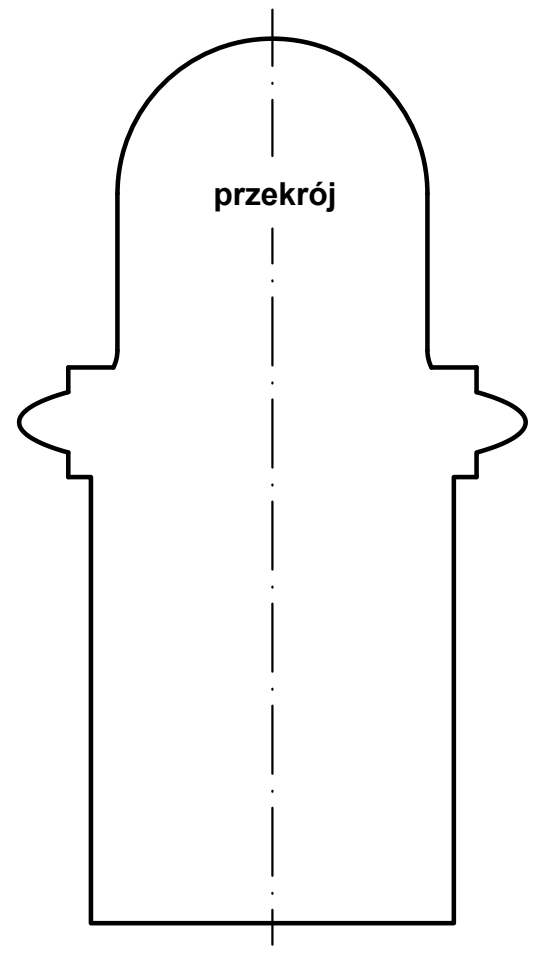
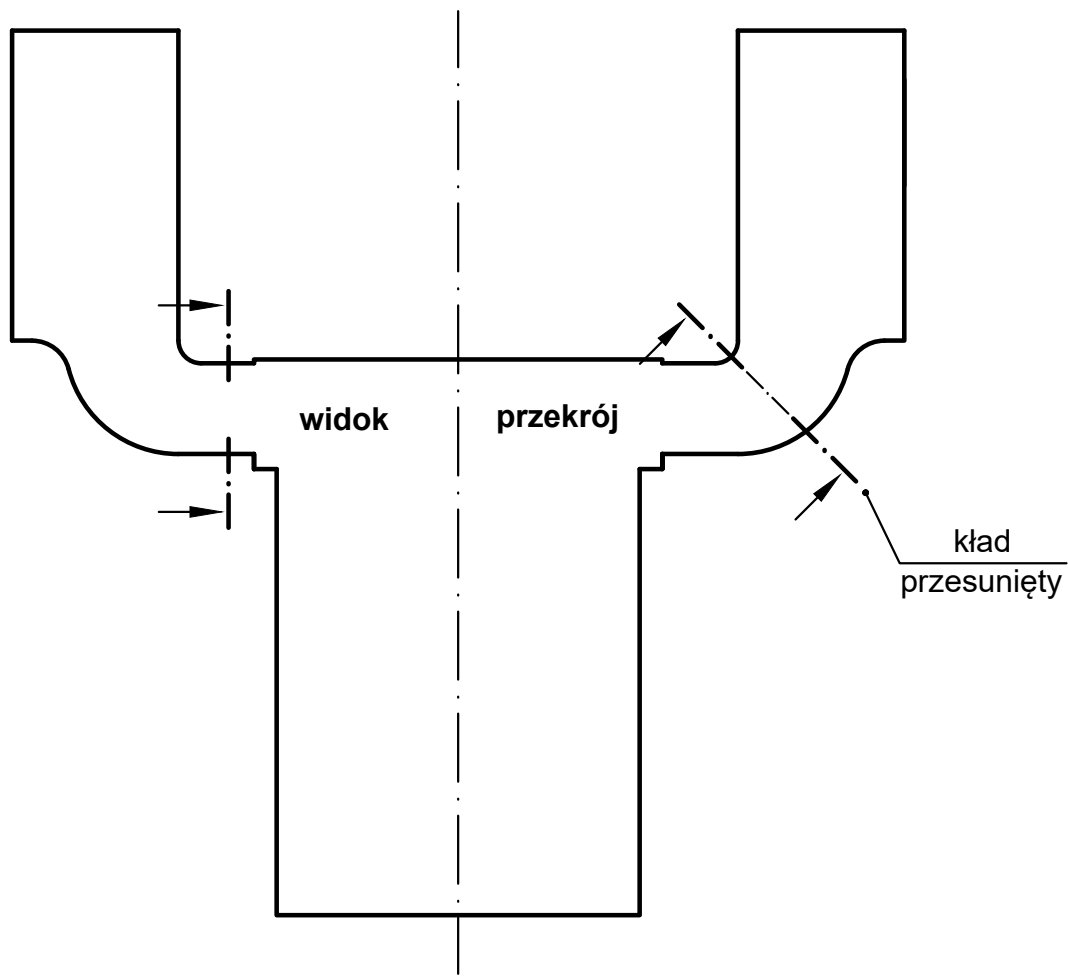

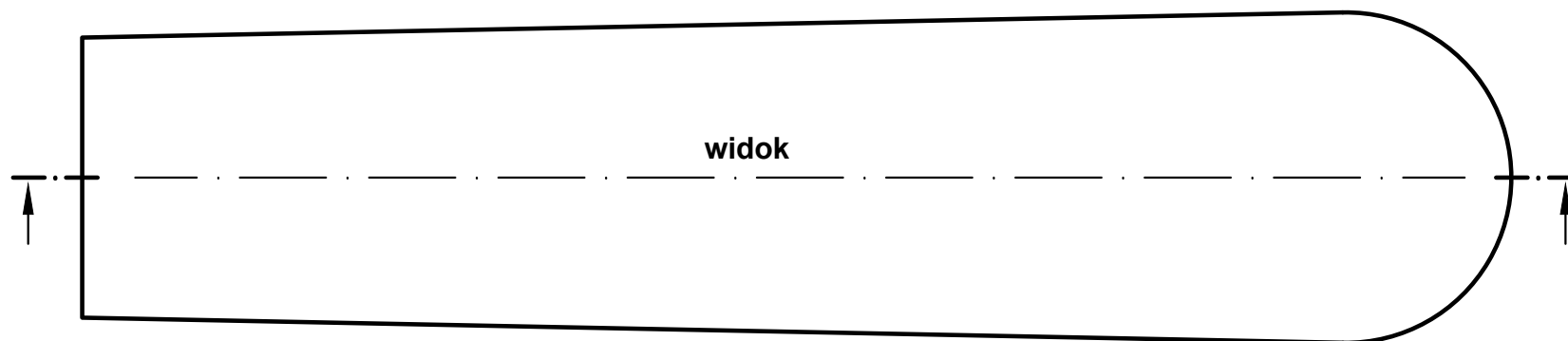
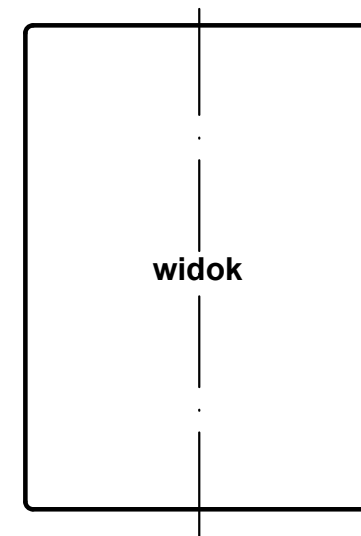
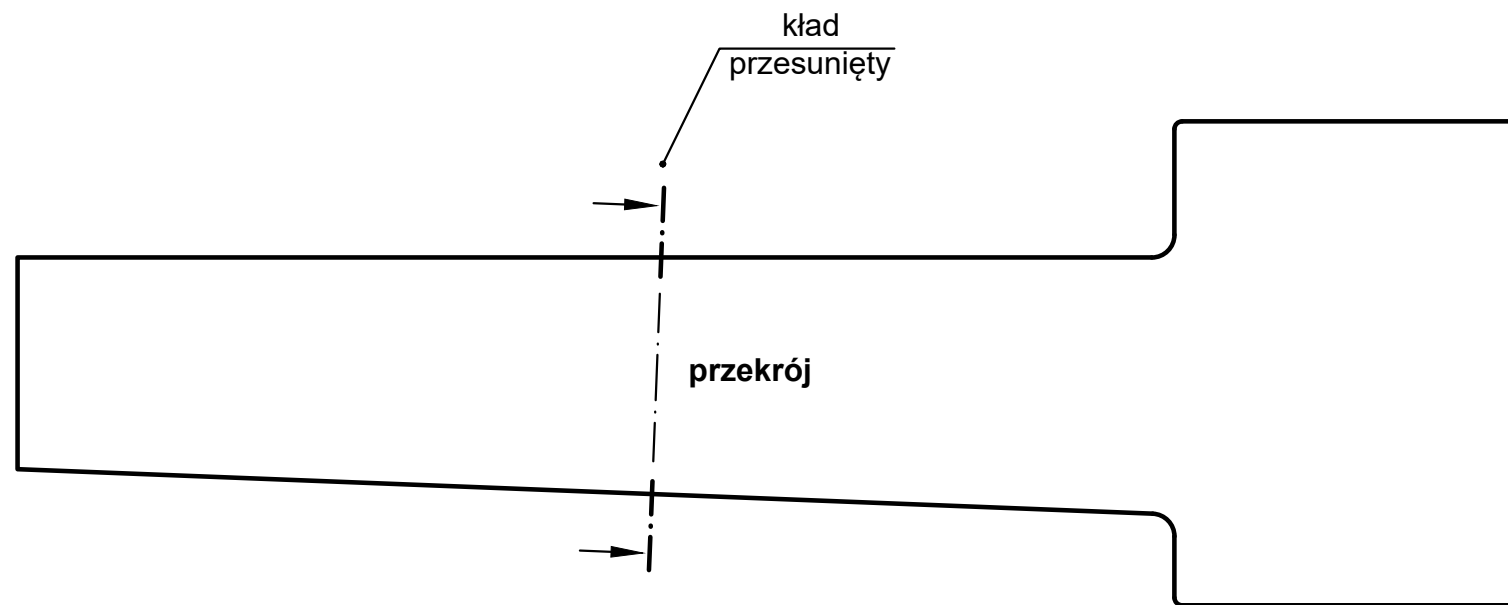

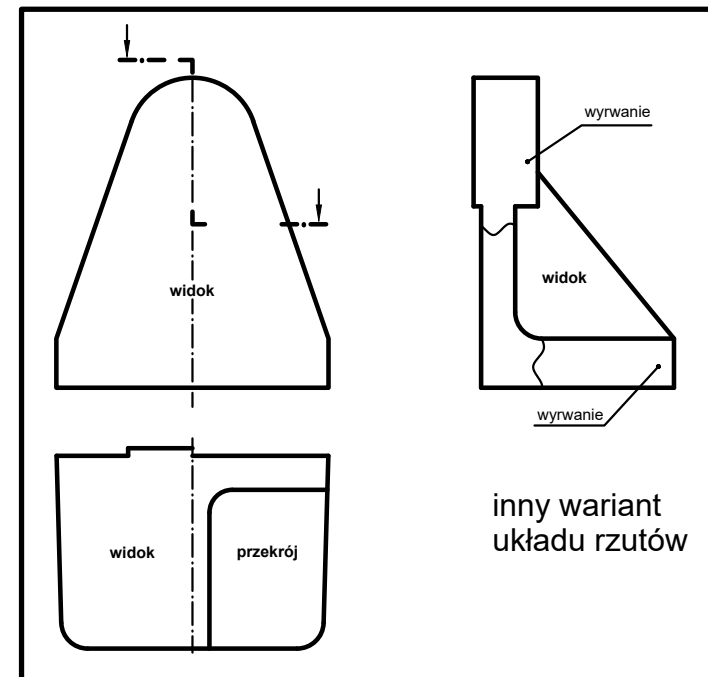
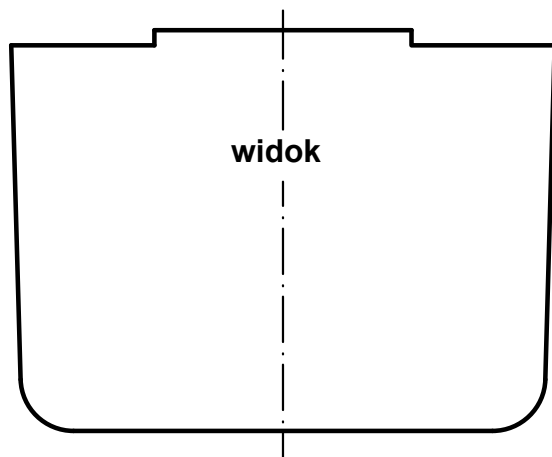
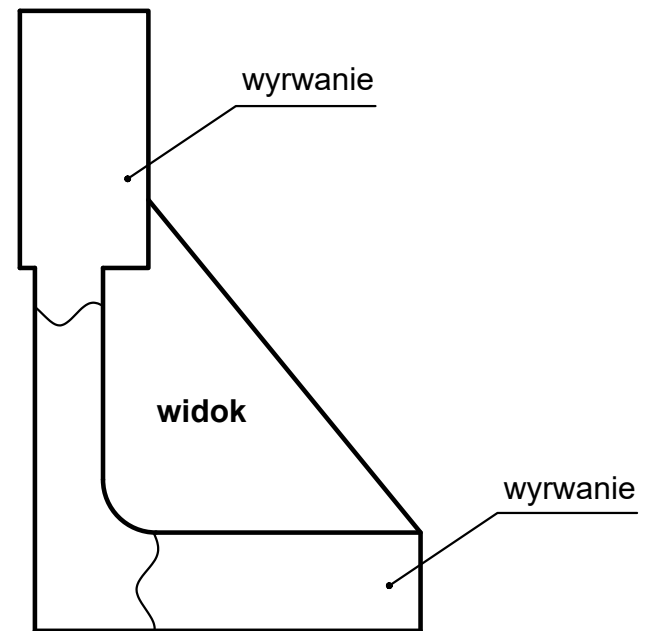
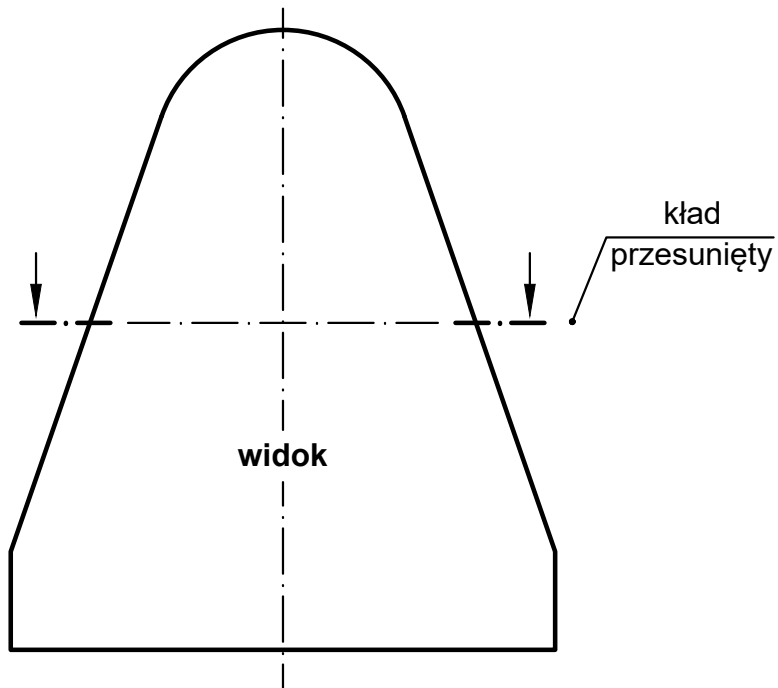

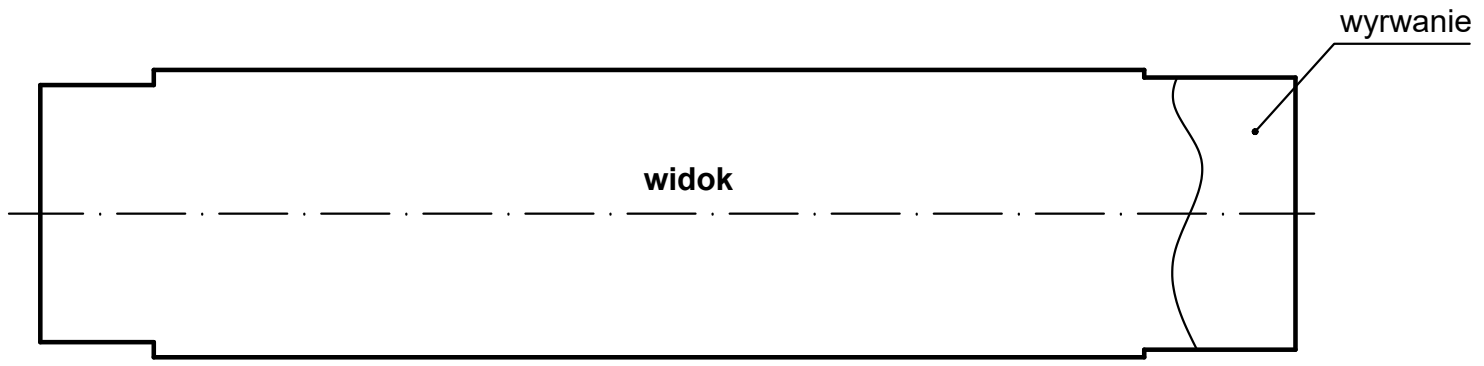
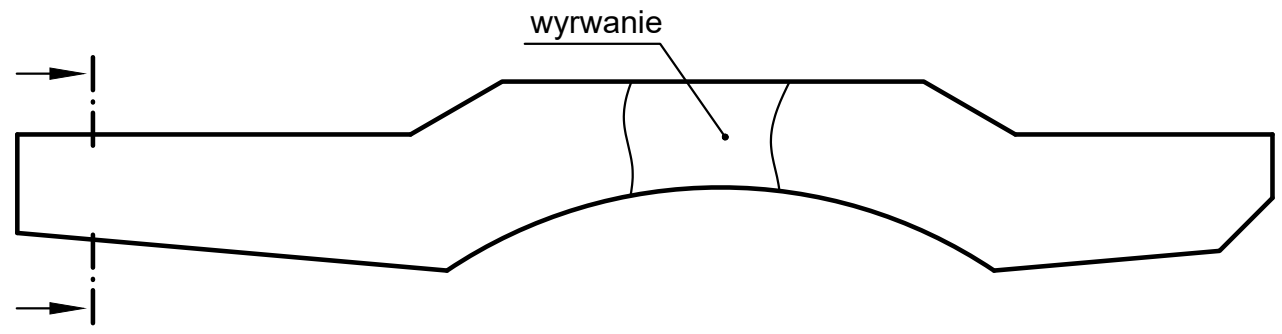
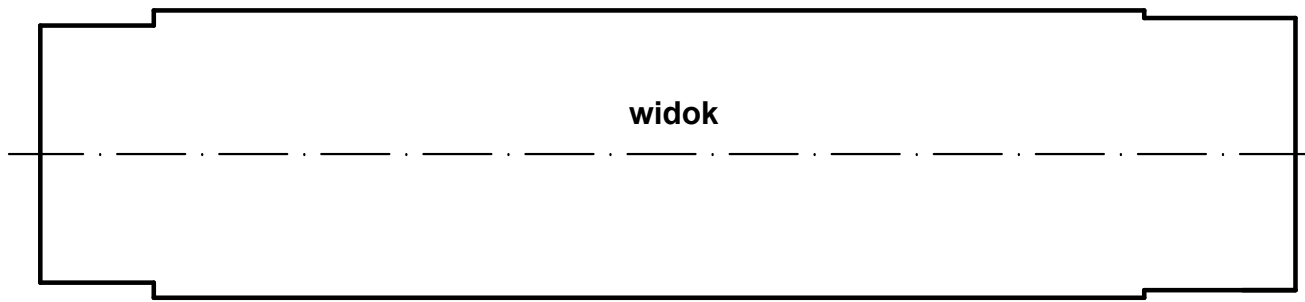

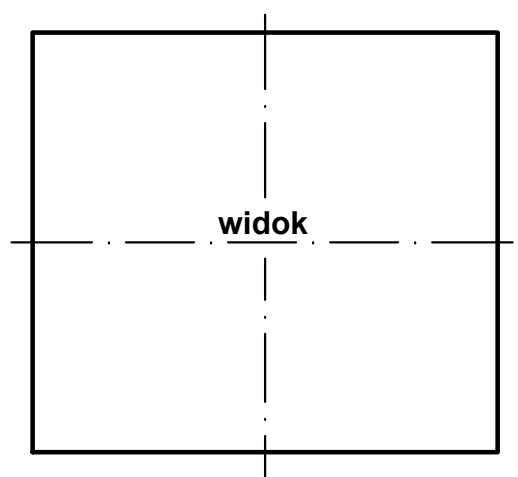
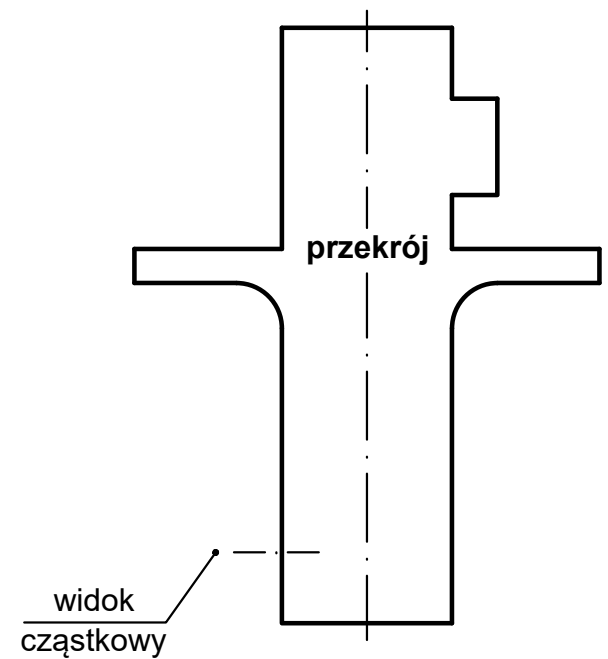
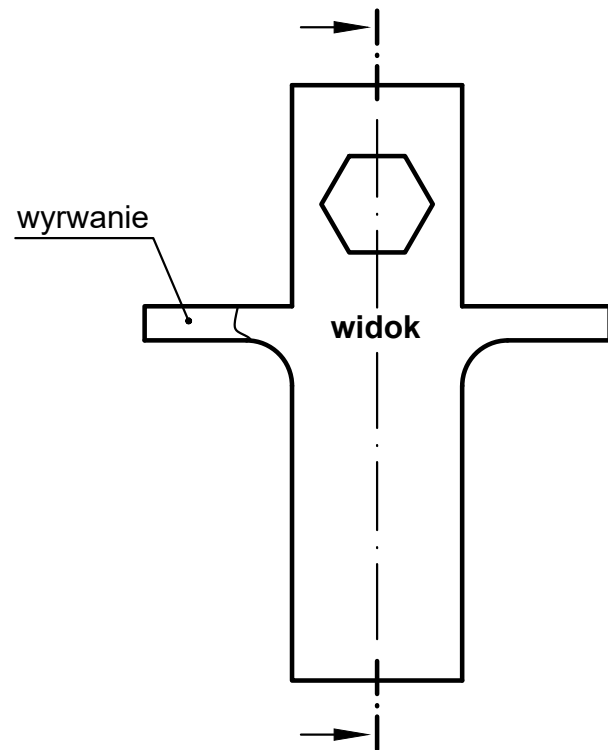

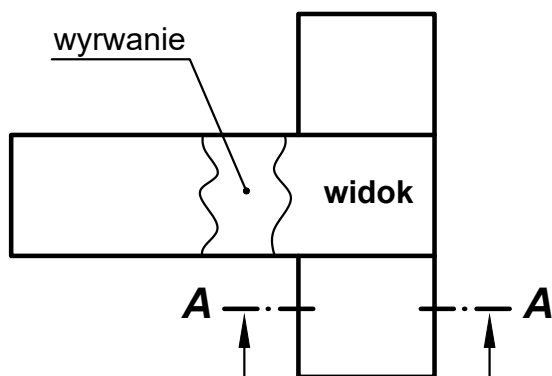
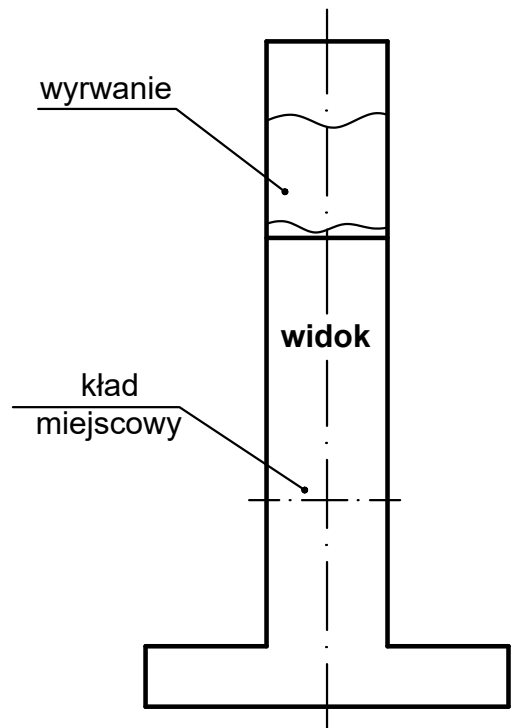
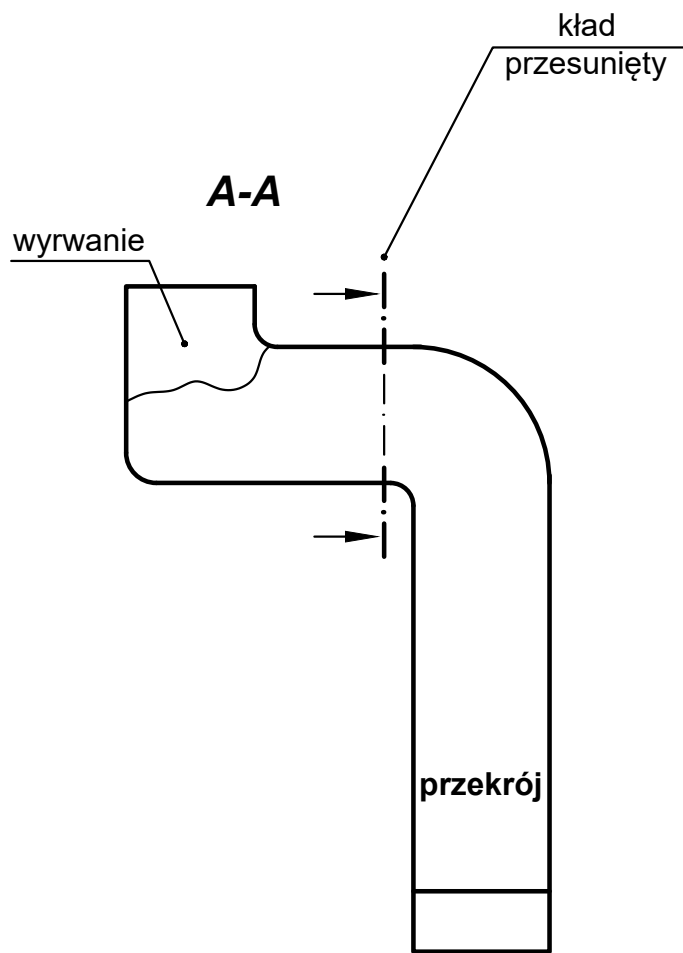

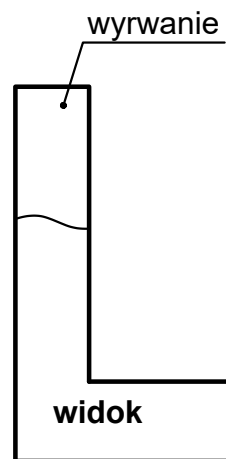
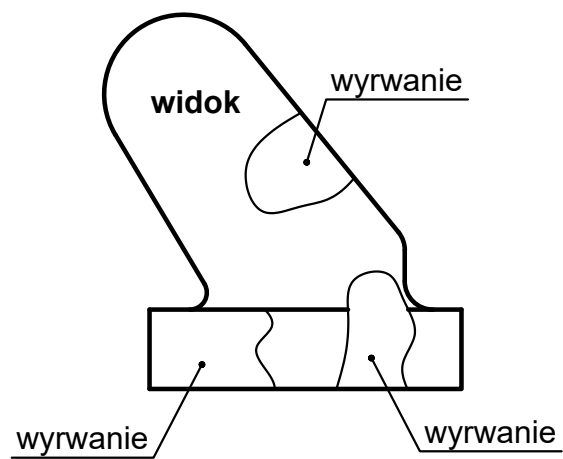

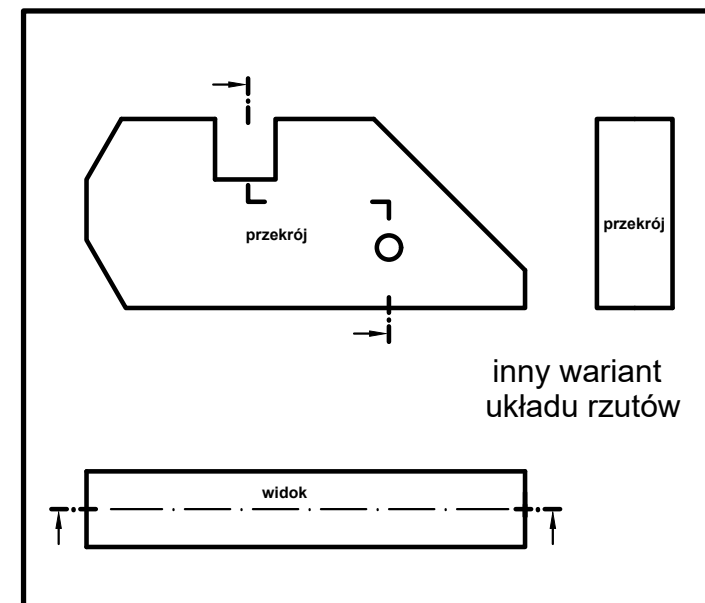
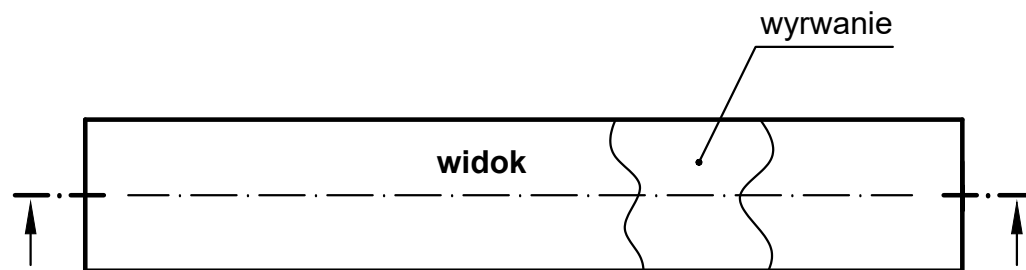
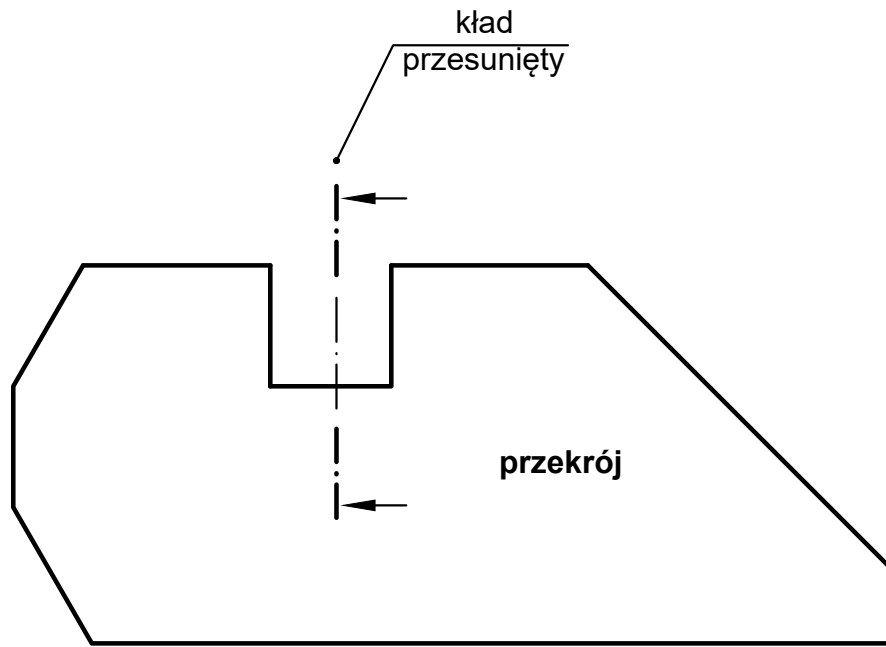



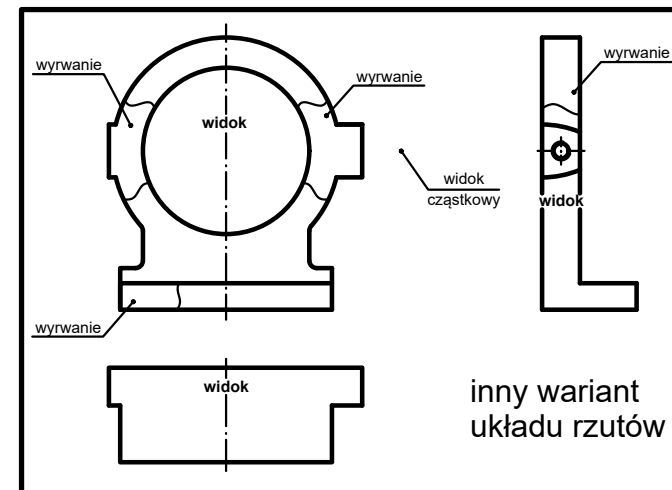
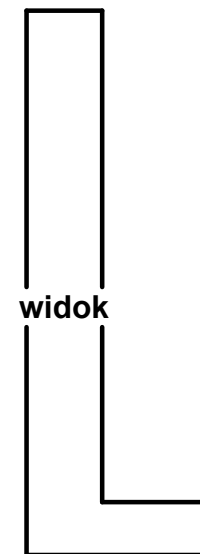
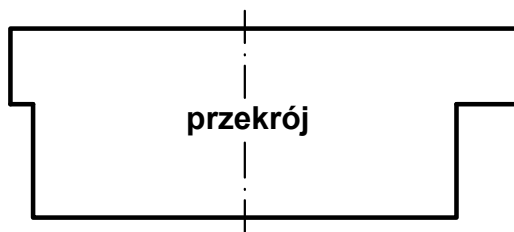
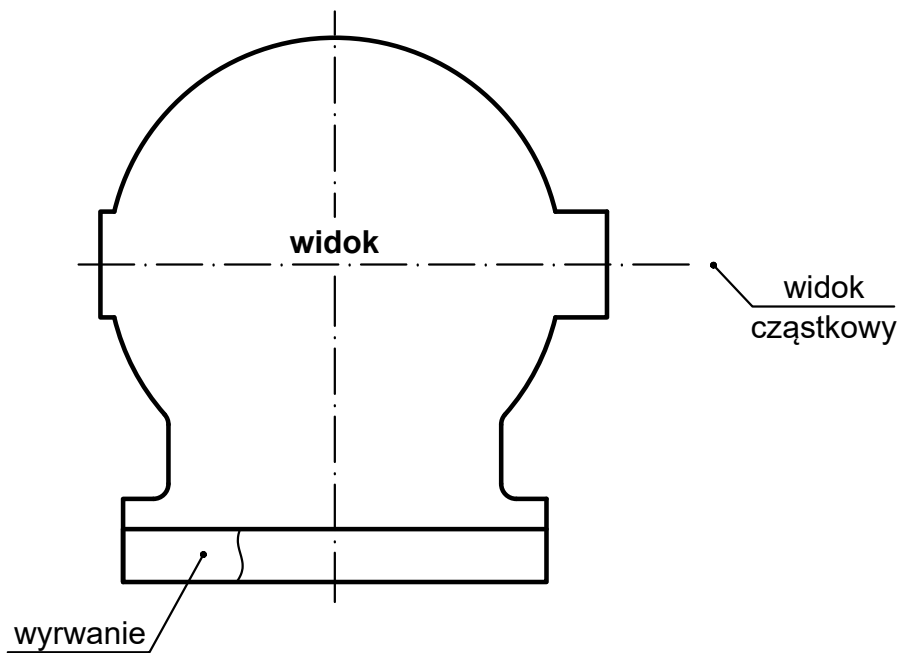

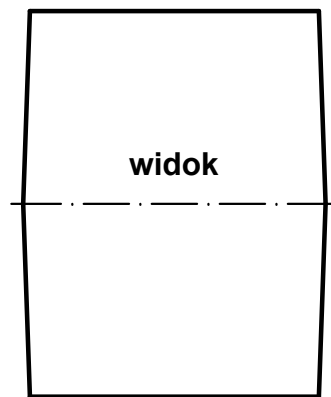
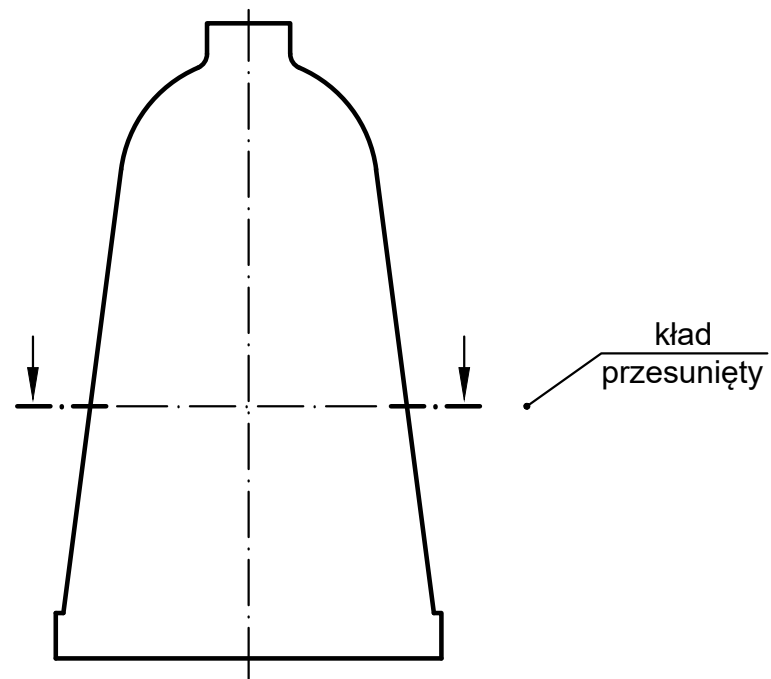
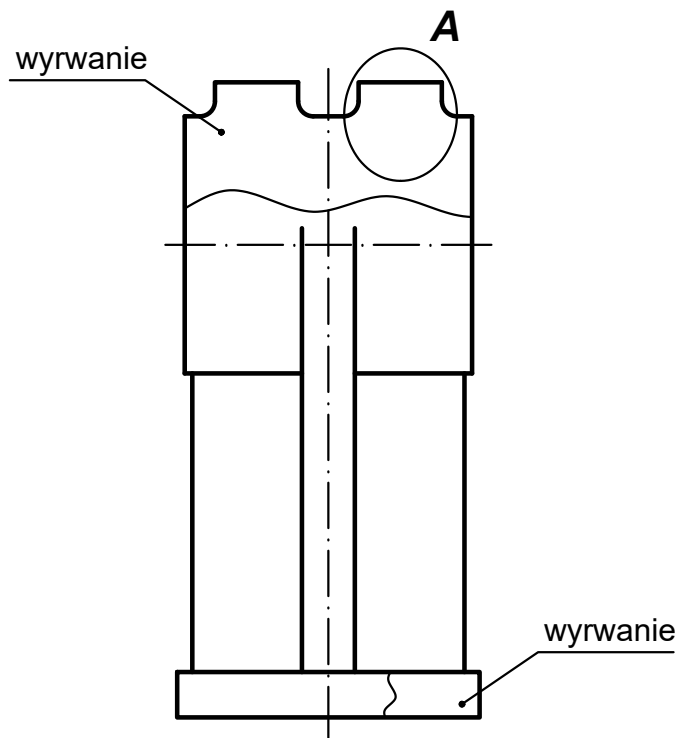

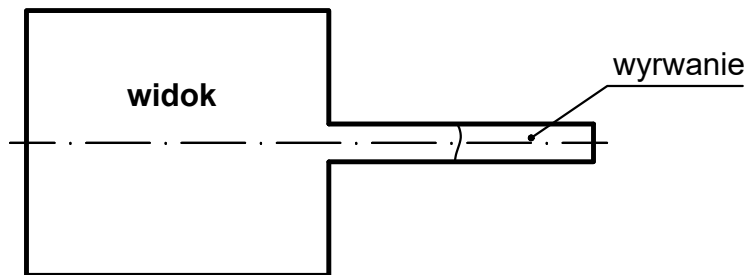
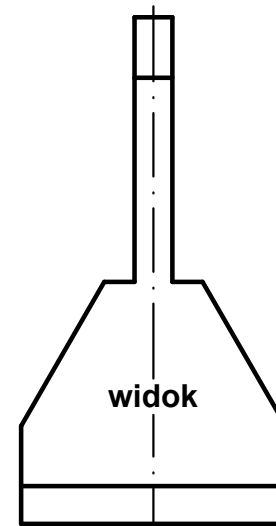
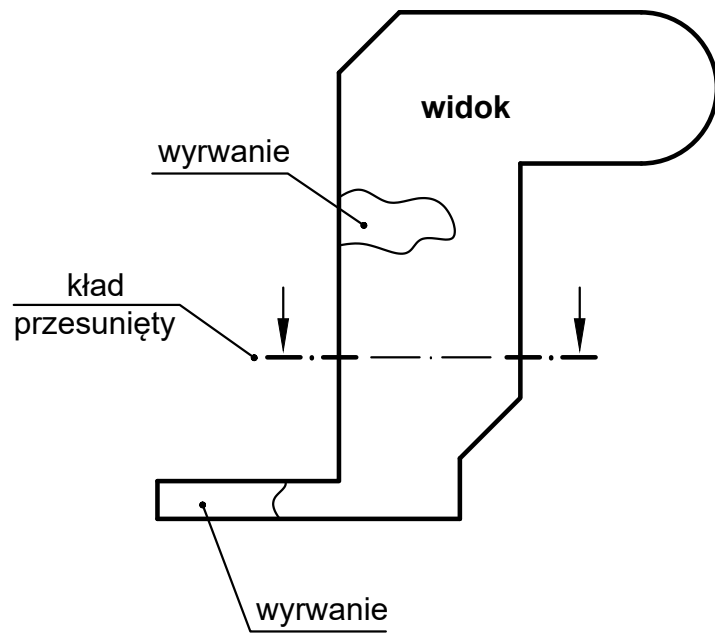

przekrój

widok

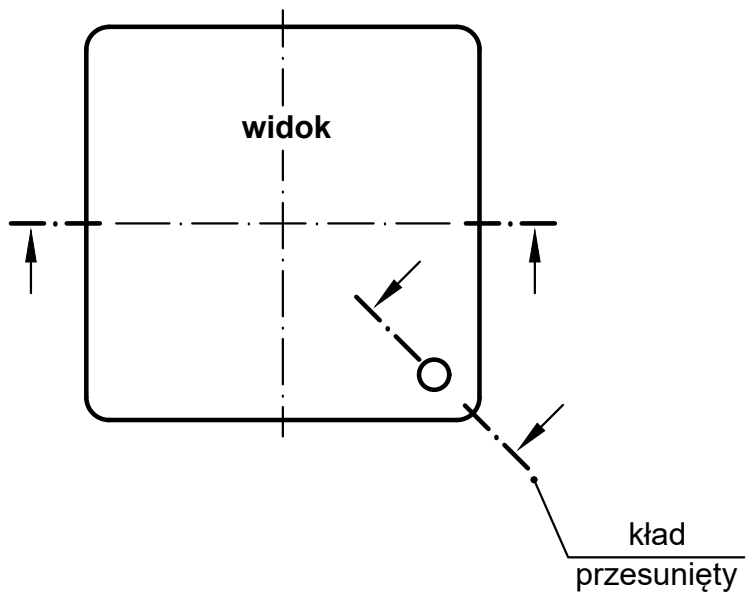

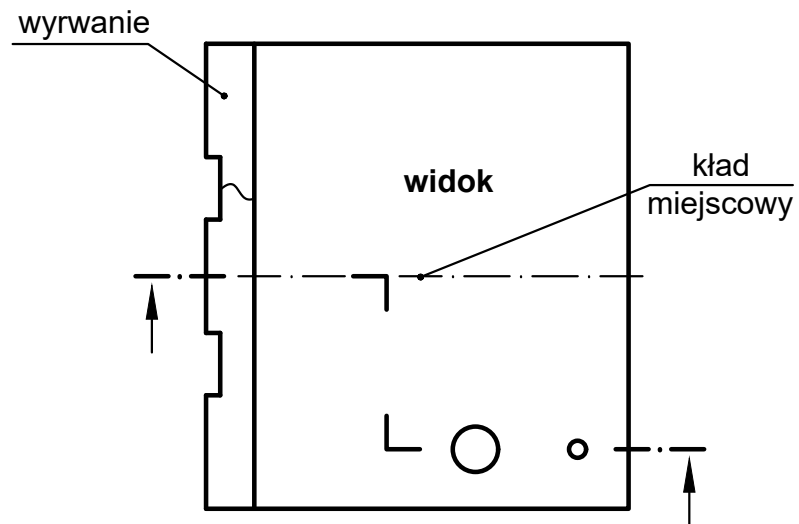
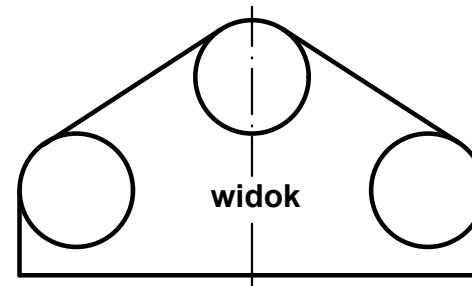
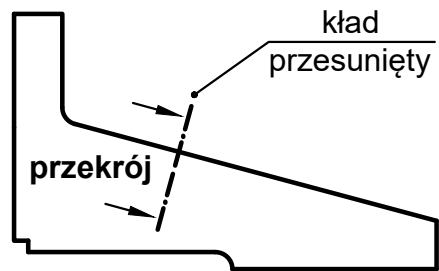

**A-A**

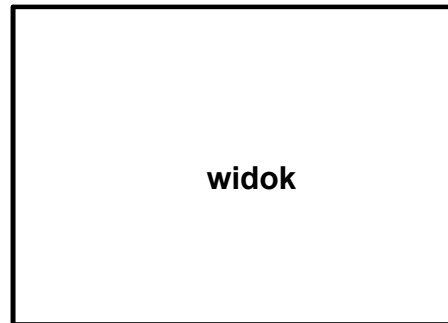
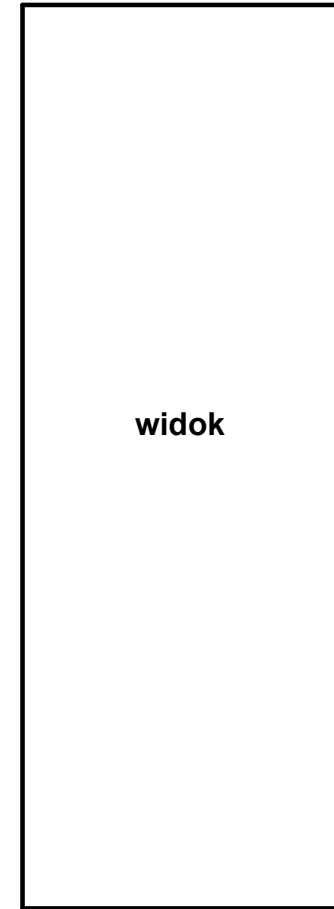
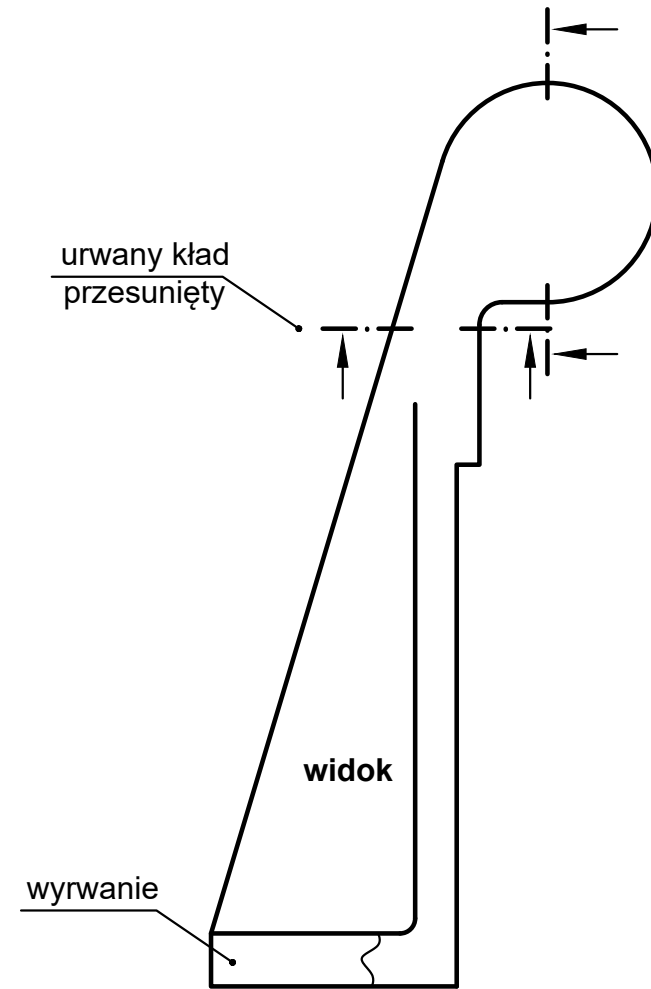
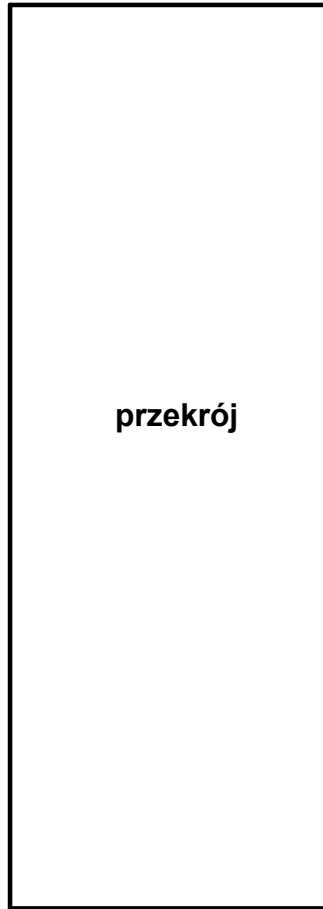

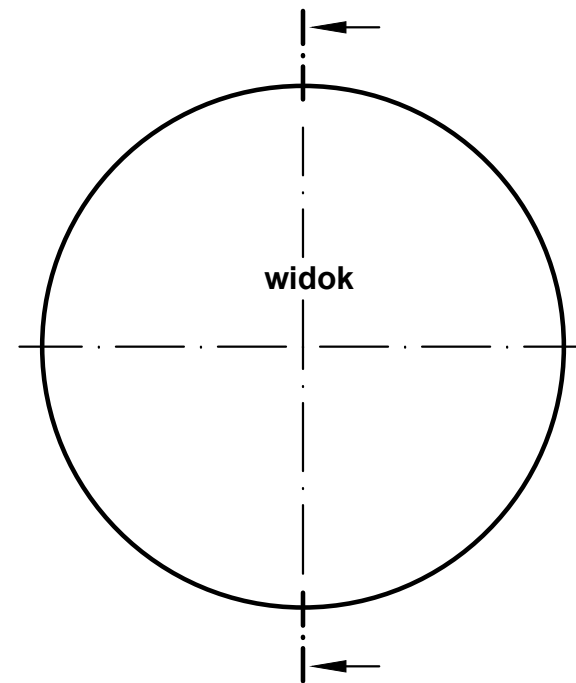
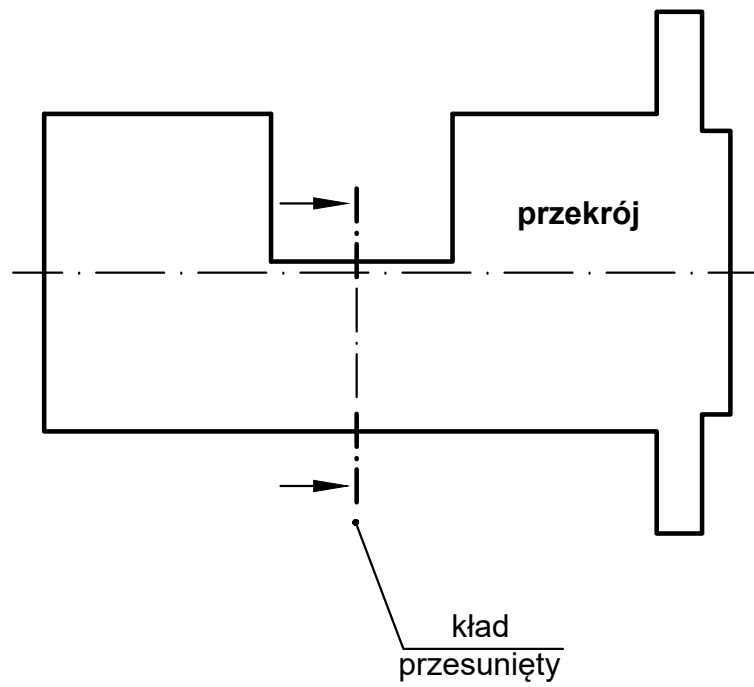

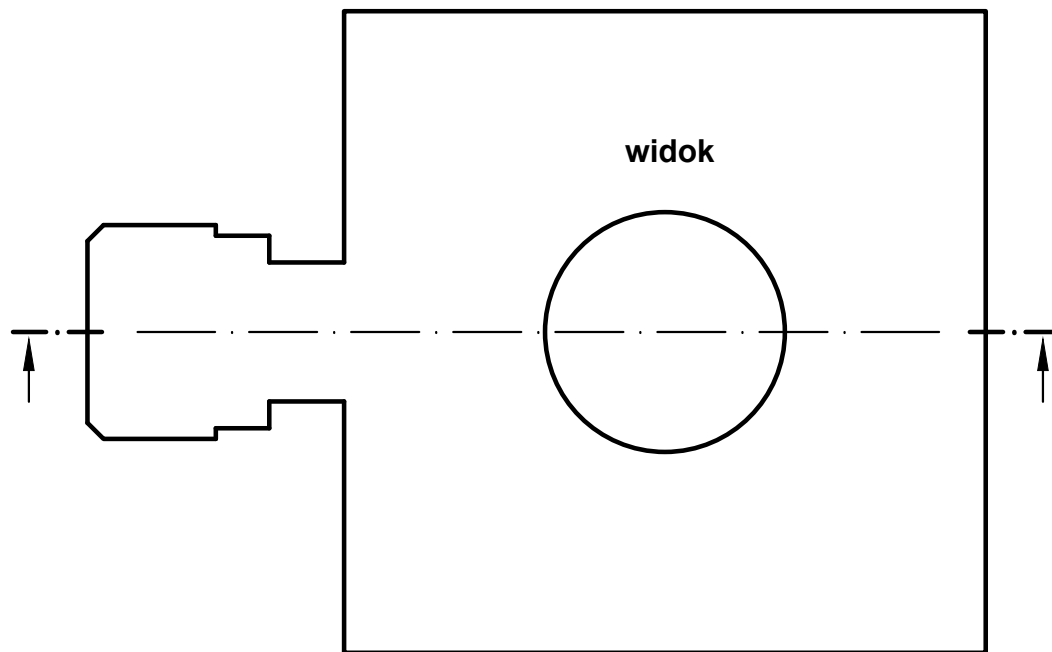
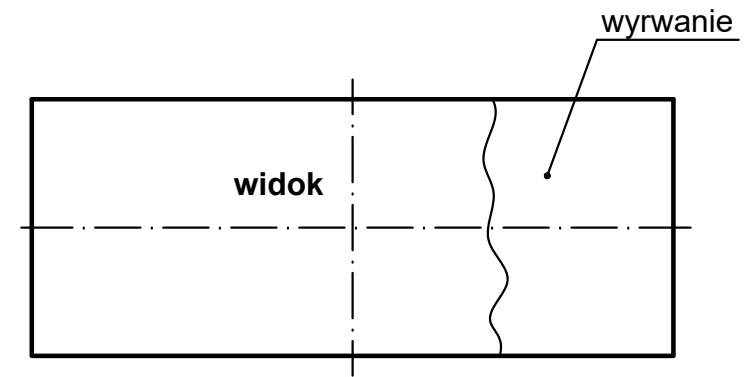
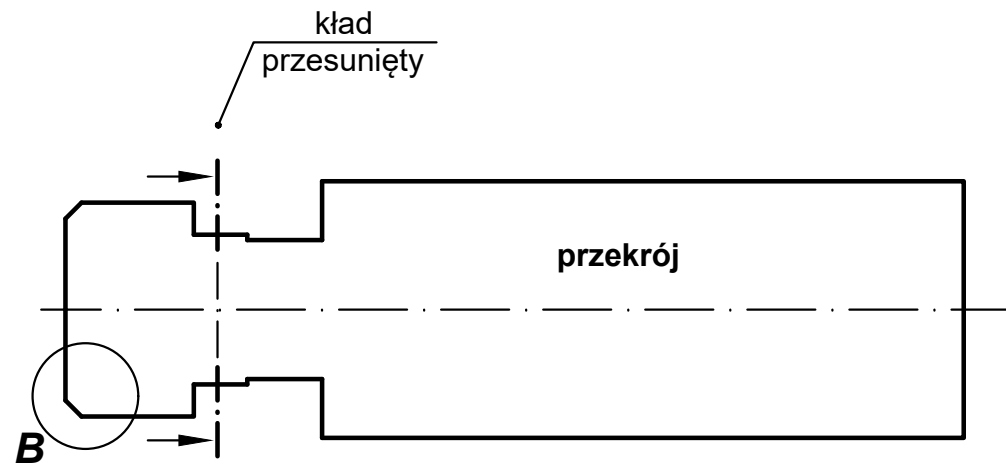

***B (5:1)***



A-A

B

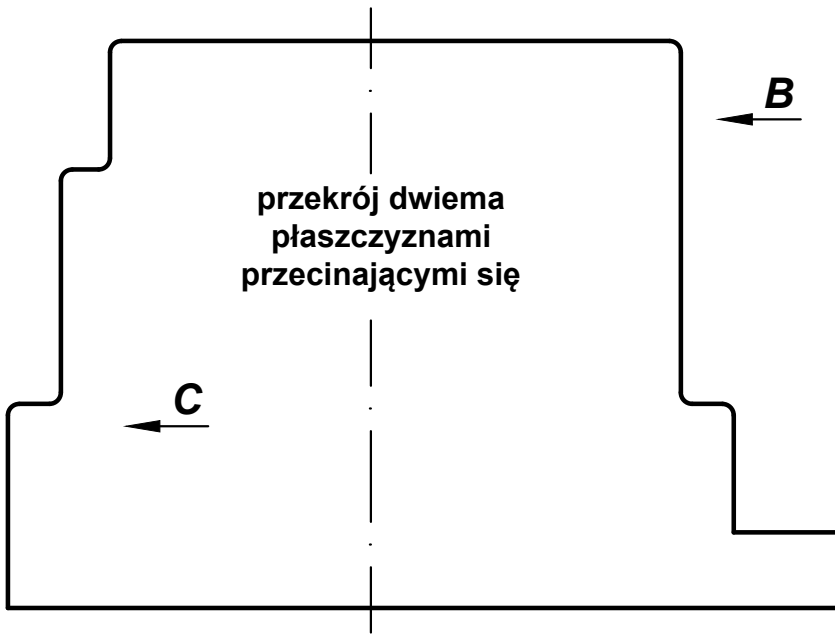

C

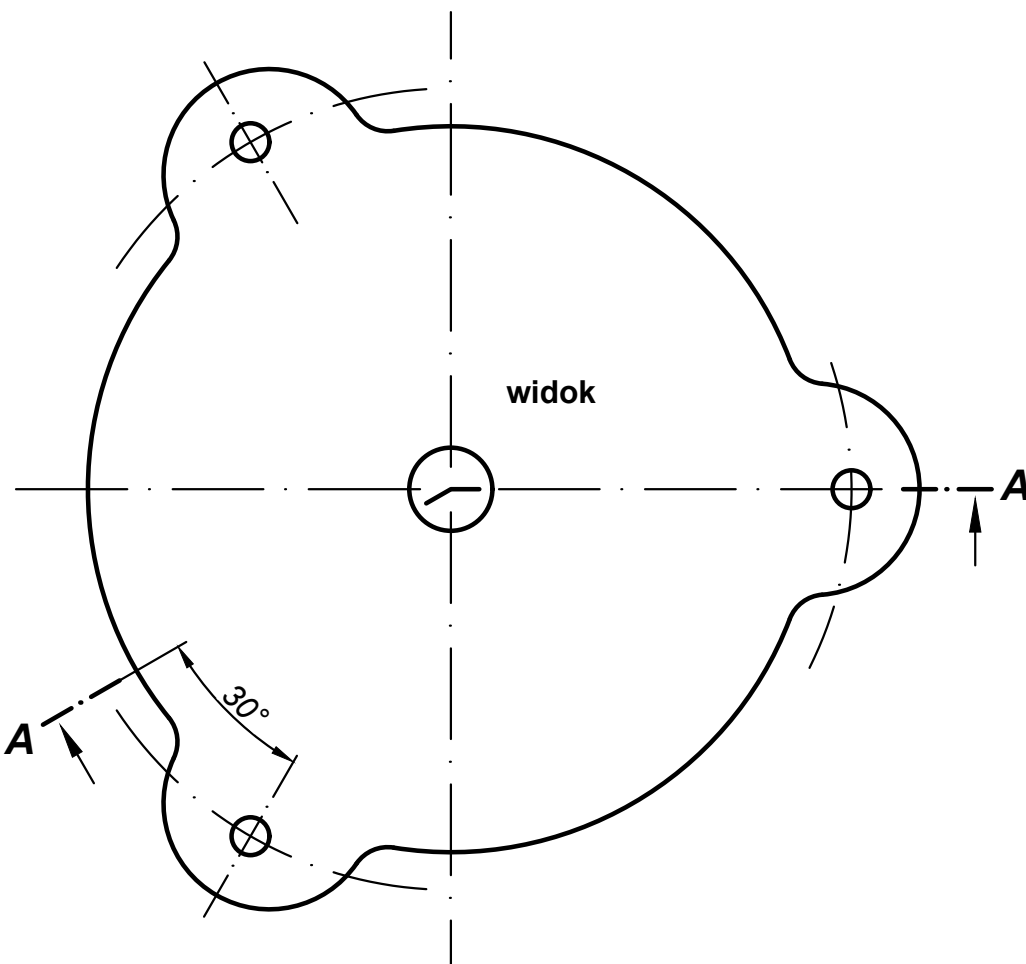

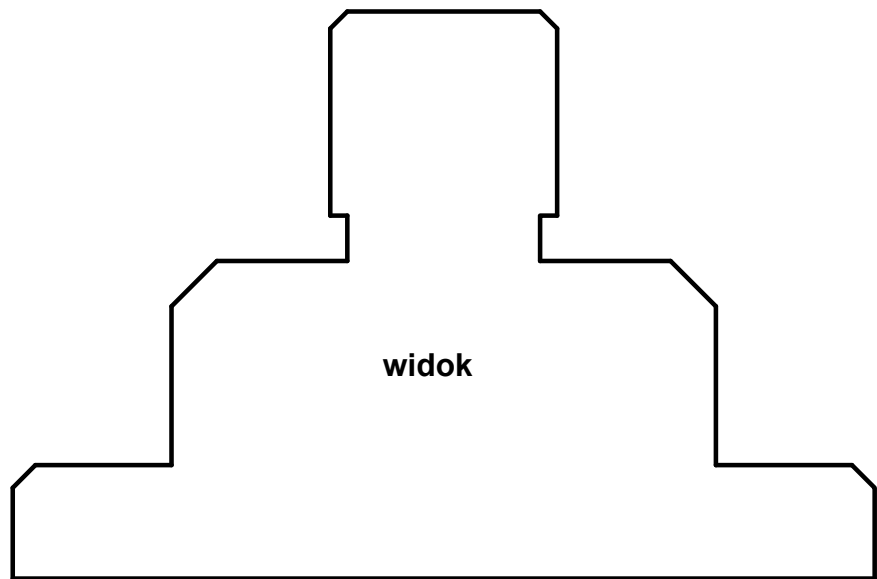

widok

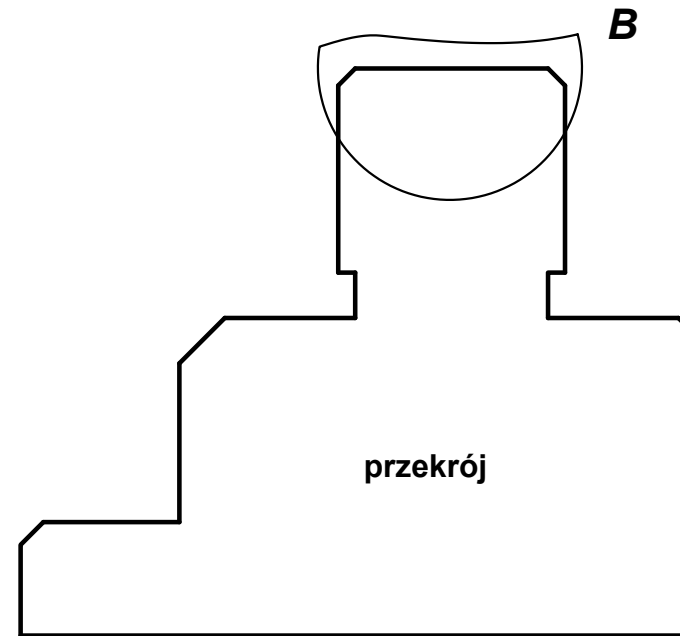

przekrój

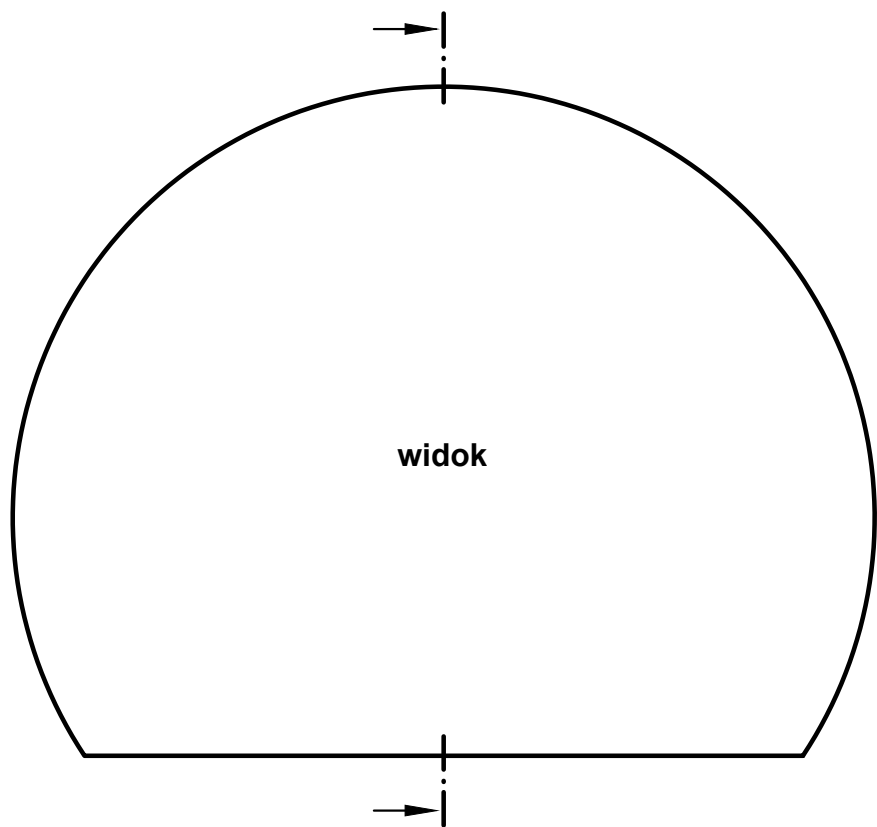

widok

***B (5:1)***

